

# GREYHAWK® ADVENTURES

Official Game Adventure

## Falcon's Revenge

by Richard W. and Anne Brown

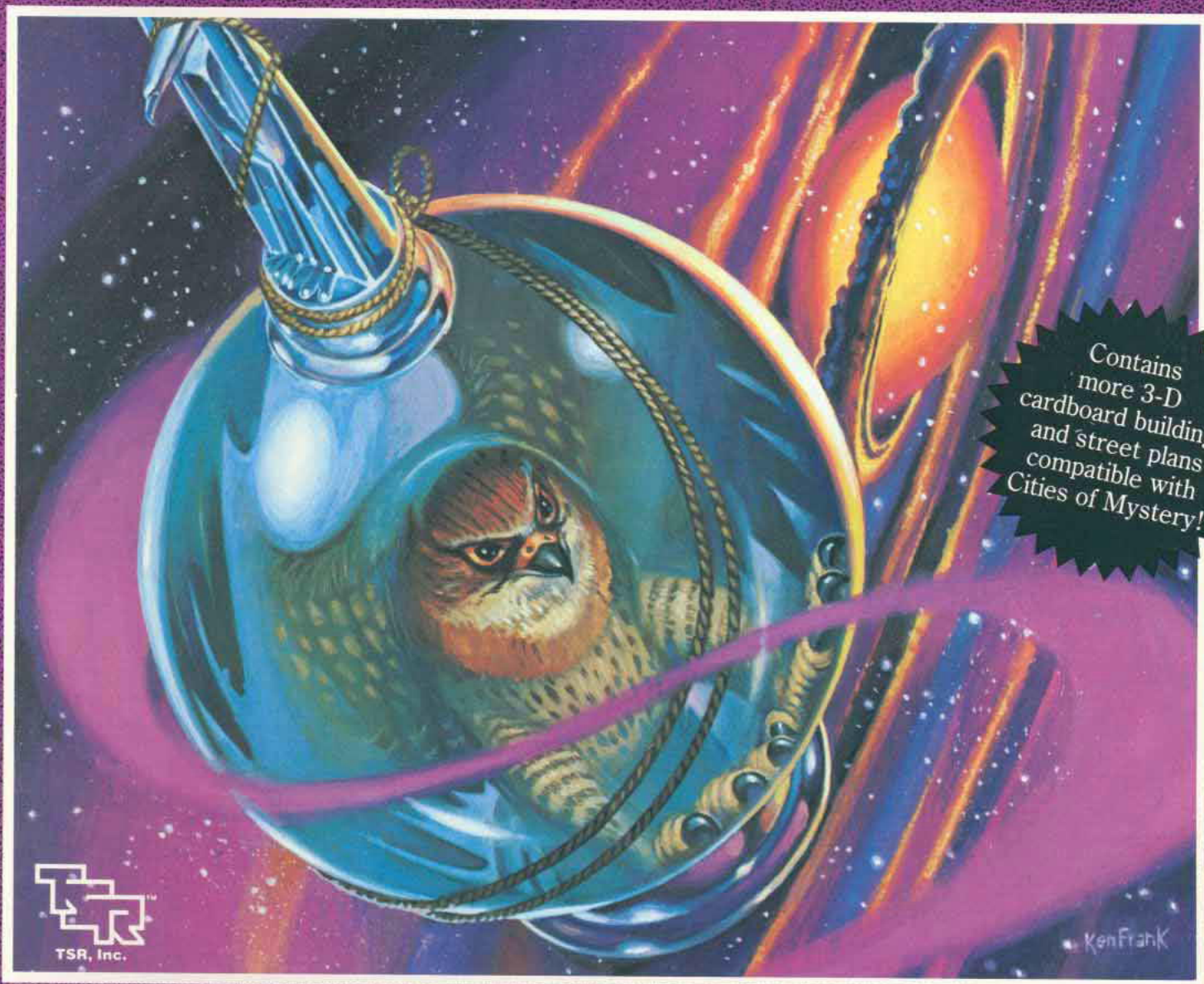

Contains  
more 3-D  
cardboard buildings  
and street plans  
compatible with  
Cities of Mystery!





# Falcon's Revenge

## Credits

**Design:** Richard W. and Anne Brown  
**Editing:** Timothy B. Brown  
**Cover Art:** Ken Frank  
**Interior Art:** Ken Frank  
**Cartography Supvr./Designer:**  
Dave Sutherland/Dennis Kauth  
**Building Fold-ups:** Frey Graphics  
**Typography:** Gaye O'Keefe  
**Graphic Design:** Stephanie Tabat

©1990 TSR Inc. All Rights Reserved.  
Printed in the U.S.A.

ADVANCED DUNGEONS & DRAGONS,  
AD&D, GREYHAWK,  
PRODUCTS OF YOUR IMAGINATION, and the  
TSR logo are trademarks owned by TSR, Inc.

Distributed to the book trade in the United States  
by Random House, Inc., and in Canada by  
Random House of Canada, Ltd. Distributed to the  
toy and hobby trade by regional distributors.  
Distributed in the United Kingdom by TSR Ltd.

This material is protected under the copyright laws  
of the United States of America. Any  
reproduction or other unauthorized use of the  
material or artwork contained herein is prohibited  
without the express written permission of TSR,  
Inc.

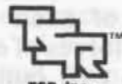

TSR, Inc.  
PRODUCTS OF YOUR IMAGINATION™

TSR, Inc.  
POB 756  
Lake Geneva,  
WI 53147 USA

TSR Ltd.  
120 Church End,  
Cherry Hinton  
Cambridge CB1 3LB  
United Kingdom

9279  
ISBN 0-88038-830-7

## Table of Contents

Introduction .....	2
Chapter 1: Interesting Company .....	4
Chapter 2: Something Rotten in Greyhawk .....	9
Chapter 3: The Plot Thickens .....	16
Chapter 4: Shacktown .....	19
Chapter 5: The Great Burn .....	23
Chapter 6: The Diary .....	30
Chapter 7: Where Evil Lurks .....	35
Chapter 8: The Spurned Cult of Iuz .....	46
Chapter 9: The Falcon Freed .....	52
Appendix 1: NPCs .....	57
Appendix 2: New Magic .....	59
Appendix 3: New Monsters .....	61
Appendix 4: Rumors .....	64



# Introduction

*Falcon's Revenge* is the first in a trilogy of modules that take place in the Free City of Greyhawk. The modules are designed to flow together smoothly. However, each module is also equipped with an appropriate alternate ending which brings the module to a satisfactory conclusion for DMs who do not wish to play the entire trilogy. Thus, any of the modules will be equally enjoyable regardless of whether the others are played.

If possible, the DM should determine whether he plans to use more than one module at the beginning of the adventure. However, the modules are designed so the alternate endings only affect the last few pages of the module. If the DM changes his mind near the conclusion of the adventure, he will have little difficulty "changing gears" to accommodate either ending.

Should the DM decide to end the adventure with the first module and later decide that he wishes to proceed with subsequent modules in the trilogy, advice is offered for circumventing this earlier decision in order to keep the story going.

## How the Module is Laid Out

The events of this adventure are presented chronologically. Certain events must happen in a specified order. Other events may occur as the PCs choose. The DM should read the adventure thoroughly before play to help ensure that the adventure will run smoothly. The DM is encouraged to add to the events listed here to enhance the atmosphere of the adventure and to adapt it to his own campaign and his players' styles.

The content of this module is meant for the DM's eyes only. The DM is free to give portions of the text or maps to the players to ease play, but for the most part, the information is directed to the DM.

Any text that appears in a box is meant to be read aloud (or summarized) to the players.

## The Setting

*The City of Greyhawk* boxed set is recommended, but not required to play this adventure. The adventure is designed to take place in Greyhawk, but it would work nearly as well in another large city with some additional work from the DM.

Most of the locations are described in detail in this adventure; the DM would need only to locate them somewhere in his own city. Other locations that are described in the boxed set are referred to the description in the box, but are accompanied by staging notes so a DM may generate an appropriate setting. For example, when the DM is referred to the description in *The City of Greyhawk* boxed set for the dungeons beneath the Grand Citadel, the DM who is not using the box set is advised to create an appropriate setting for a small section of the dungeon of a large city. The sections that a DM might need to generate are generally more generic settings (such as a jail cell) that should be easy to design.

If the DM is using a city other than Greyhawk, he should make certain that the city has the following features:

*Burned section*  
*Sewer system*  
*Wealthy neighborhood*  
*Marketplace*

*Slums*  
*Large Temple*  
*Several city gates*

## Locating References

When information from another source is required, the page number of the reference is given along with an abbreviation of the book in which it is found. *PH* refers to the AD&D® 2nd Edition *Player's Handbook*. *DMG* refers to the AD&D 2nd Edition *Dungeon Master's Guide*. *GA* refers to the GREYHAWK® Adventures hard-bound book. Two references are from *The City of Greyhawk* boxed set: *GoF*, indicating the "Gem of the Flanaess" booklet, and *FFF*, indicating the "Folk, Feuds, and Factions" booklet.

## Overview

To assist the DM, the following is a brief summary of the events of this module.

Many years ago, the City of Greyhawk was infiltrated by an evil cult whose members desired to destroy the government and drive away the citizens. They hoped to establish Greyhawk as a city of evil life, devoted to the cult.

The followers of St. Cuthbert discovered the secret, and a battle was declared against the members of the cult. A specially chosen force of four—a cleric, a paladin, and two mages fought to save their city.

The forces of good eventually overcame the forces of evil. Rather than put the evil cult leader to death, the heroes decided to imprison her, alone, for all eternity. A special dimension was opened for her, and she was cast inside. The portal was finally sealed, and the

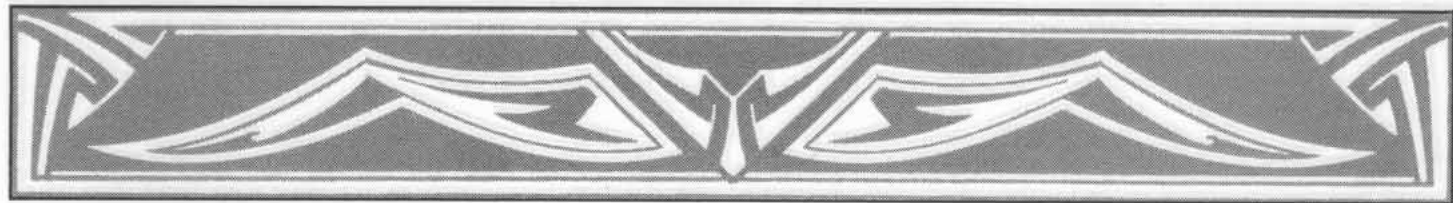

citizens of Greyhawk were able to return to their normal lives without even realizing the evil that threatened them.

All of the cult members were killed. The youthful members, however, were spared. They became determined to bring their cult to power. They have been careful over the years to keep their plot a secret. Now, they are preparing to work the magic that will free their imprisoned leader. Cult members have infiltrated many levels of the city government in order to keep their secret from the higher officials.

The PCs will unknowingly stumble onto this plot. They must not only stop the cult's activities, but they must first unravel the secrets of the cult and learn what they are up against.

## Using the Rumors Table

The final page of this module lists many rumors that the PCs will encounter at some time during this adventure. At certain points throughout the module, the number of a rumor will be indicated. Read the players that rumor at that time. At other points in the module, random rumors are indicated. Roll 1d20 and read the appropriate rumor from the table. Check off the rumors as they are used.

Some rumors are true; others are not. Only the rumors that are designated "confirmed as true" are true; the rest are only tall tales. When rolling for random rumors, read the false rumors *only once*. If the number of a false rumor is rolled a second time, ignore that roll and reroll for another rumor. Rumors that are true may be read any number of times. Following these guidelines should help to keep the PCs on track and avoid "wild goose chases."

If the PCs are confused or need a push in the right direction, feel free to read rumors as necessary. These can provide helpful hints in times of need without spoiling the plot for the players.

## General Advice

This adventure is somewhat unusual. Before the players can accomplish their mission, they must first figure out *what their mission is*. The PCs stumble into this adventure quite by accident, and realize that something funny is going on long before they unravel the entire problem. Pieces of the puzzle fall into their laps; at first, to arouse their suspicions, and later, to help them discover the plot.

Once the PCs have learned the whole story, they can begin to defeat the evil that threatens the city.

If the PCs begin to stray off course, there are several ways to nudge them back on track.

1. Provide them with one or more appropriate rumors from the rumors table at the end of this adventure. This may give them the clue they need to get back on track.

2. Use Talasek to offer suggestions for finding information. For example, if the PCs are able to find clues in Greyhawk's marketplace, but none of the players think to investigate the market, let Talasek suggest it. He can be used very effectively to guide the players in the right direction.

3. Ask the PCs to make an intelligence check. PCs who make the check have a sudden burst of inspiration that never occurred to the *players*. Simply inform the players of the idea the character has. For example, using the market example above, the PC who makes an intelligence check might suggest a trip to the market rather than Talasek.

Use caution not to give out *too much* information. Overexplaining can spoil the fun and reduce the sense of suspense and mystery that is so important to this adventure. It can also give players a sense that the adventure will unfold as planned regardless of their actions and decisions. A good DM can ration the clues he gives so the players maintain a sense of control, discovery, progress, and ultimate success.

## A Note About AD&D® 2nd Edition Rules

This adventure is written using the terminology and rules of the AD&D® 2nd Edition game, but is still easily playable by those who are using the original game materials.

Some of the more noticeable differences are changes in name only. The term "magic-user" has been replaced by "mage" (or, in a few places, the more general designation of "wizard"). The "cleric" character class is now the "priest" class, although members of that class are still usually referred to as "clerics." "Fighters" are now called "warriors" and "thieves" are now called "rogues."

Another significant change is the presentation of monsters. The descriptions of the new monsters designed for this adventure are identical in format to the presentation of monsters in the new *Monstrous Compendium* series. Although the information is organized differently and has been somewhat expanded, nothing from the original format has been omitted; everything that "1st Edition" DMs are accustomed to seeing is still provided in the new descriptive format. The pages on which the new monsters for this adventure appear can be photocopied and inserted in a *Monstrous Compendium* binder if the DM so desires.



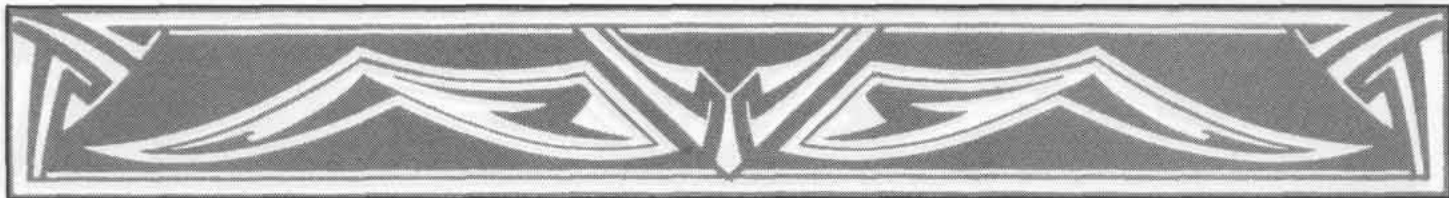

# 1: Interesting Company

The adventure opens as the PCs arrive in the City of Greyhawk. They should arrive with no immediate plans, perhaps passing through the area on their way home from an adventure, or perhaps on a holiday with nothing more than plans for fun and sight-seeing.

The party will stumble onto the plot of this adventure completely on their own. When they arrive in Greyhawk, they will have no inkling that anything is wrong. They have not been hired to investigate, nor have they heard any rumors of evildoings.

## Adventure Around Every Corner

The party should arrive in Greyhawk tired and dusty from a long day of travel. They should arrive in the late afternoon or just before nightfall, eager to find lodging and a hot meal. Route the party so that they enter the city through the Marsh Gate, if possible. The Druid's Gate would be a good second choice if the party has a problem reaching the Marsh Gate. Since the gates of Greyhawk are frequently under repair, this is a good excuse to have a closed gate, forcing the party to find another entrance (the men working on the gate will suggest the Marsh or Druid's gates).

If the adventure is being played in a city other than Greyhawk, make sure to coordinate the arrival of the party with a location convenient for them to find The Whistling Fish.

When the party approaches any of the city gates, they will be asked to sign the roster. This is customary for all persons entering

Greyhawk. Those carrying swords will also be asked to pay the Freesword Tax of three gp. (See page 44, GoF, for more detail on these customs.) If the adventure is not taking place in Greyhawk, these activities may be omitted or enhanced at the DM's discretion.

Once the party has made its way through the gate, they will witness a bustling, busy city. Shops and homes line the streets, tended by merchants and housewives. Children play and tend to their chores, and animals are led by farmers and butchers. The sounds and smells of supper being prepared fill the air, enhancing the hunger and weariness of the PCs.

Arrange for the party to visit one or two inns in an attempt to find lodging, only to be turned away. Adventurers are having difficulty finding lodging lately, as they will soon learn. Some innkeepers openly refuse to rent rooms to adventurers, while others offer weak excuses and seem nervous just having adventurer-types on the premises. Adventurers seem to attract trouble to their lodgings, although this phenomenon seems to have manifested itself only within the last six to eight months. A few of the innkeepers find this odd, and many of them don't remember ever having this kind of trouble renting to adventurers. Other innkeepers are too dull to have noticed this unusual trend.

## The Whistling Fish

This inn is important to the adventure. The DM should refuse the PCs lodging (in the form of distraught innkeepers) until they reach the Whistling Fish.

The Whistling Fish is located in the River Quarter along Marsh

Street. Since this is a fairly major street, the PCs should not have difficulty finding it. Refer to the map on the inside cover of this module for its exact location.

The road on which you travel soon branches into a four-way crossroads, forming an elongated x-shape. Various shops and stores line these streets, but your attention is drawn to a large, well-kept inn on one of the triangular parcels of land formed by these roads. A freshly painted sign in the shape of a plump fish bears the name of this interesting establishment: The Whistling Fish, Potentate of Potations.

The inn is built of the half-timber construction common to Greyhawk. Its size, however, makes it unique. From the positions of the inn's windows, the building appears to have two floors, but the structure looks far too tall to be an average two-story inn. Its roof, made of wood shakes, towers above the other buildings in the neighborhood. Even the front door seems unusually tall.

By now, the adventurers should have been turned away from at least one or two inns, and they should approach The Whistling Fish somewhat eagerly. If they do not wish to visit The Whistling Fish, encourage them to enter. Their adventures will begin soon after they take up lodging here.

A shaggy lawn surrounds the inn. The grass is a color peculiar to Greyhawk: the blades are a deep green along the edges but are dark red down the centers.



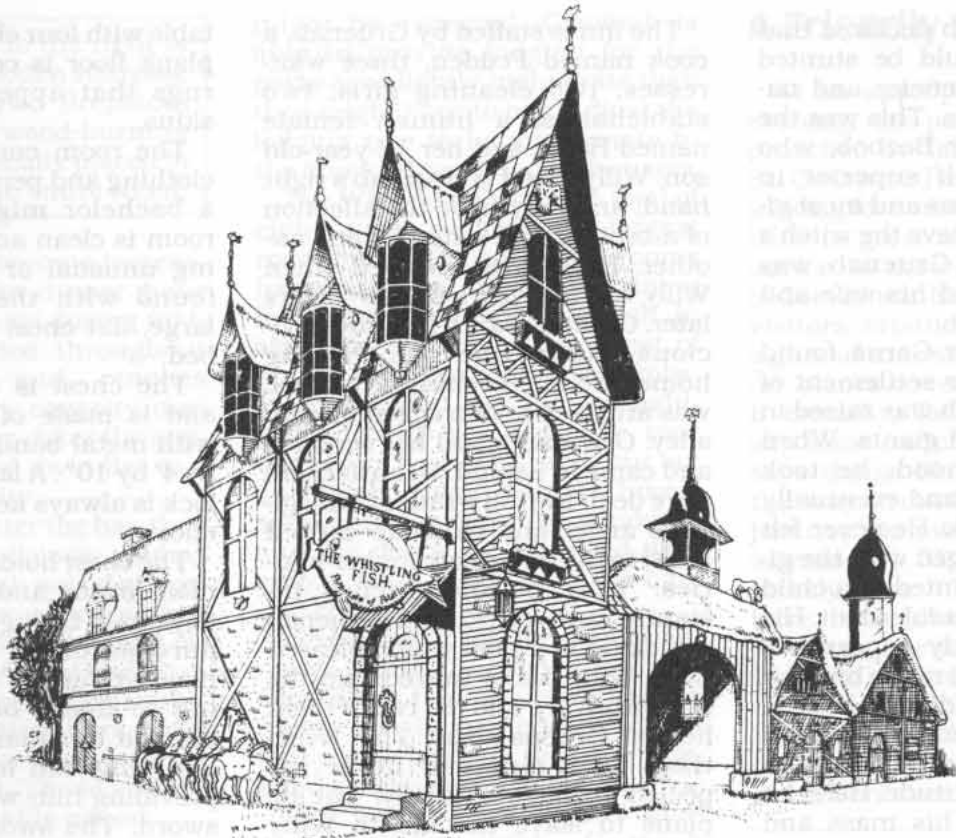
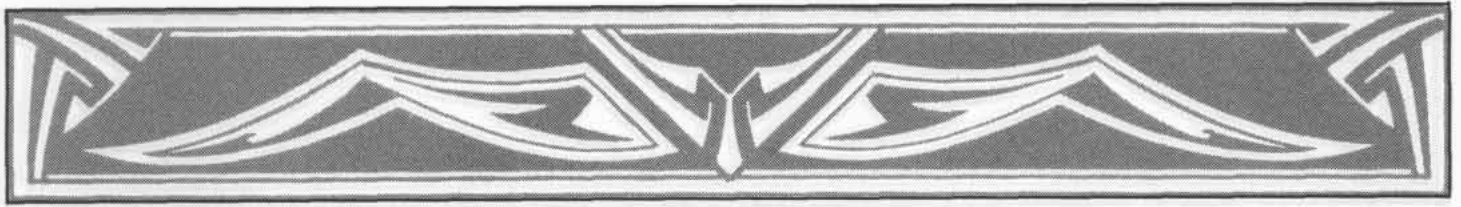

Natives of Greyhawk can tell you that although the color is unusual, this grass has one distinct advantage: it has a bitter taste that only goats can tolerate. This prevents the grass from being chewed away to nothing by other animals.

Gravel paths lead to the front door and to the adjoining stable. A long hitching rail runs along the front of the building. Although seven horses are tethered here, there is room for at least another dozen animals.

The PCs can freely walk around the inn or investigate the stable if they wish. They find nothing unusual, but they notice a cottage behind the inn of the same unusual proportions as the inn. The description of the cottage follows later.

The proportions of the stable are on a normal scale. The stable is built of wide wooden planking and has a sod roof. The roof is nearly flat, but is mounded in the center and slopes gently toward the sides. Two goats are grazing on the roof. The doors to the stable are open, and a boy of about fourteen is inside brushing one of the horses. There are four horses inside, and they appear to be permanent residents, since their names appear above their stalls: Sharna, Myrna, Gabe, and Gus. A wagon and a cart stand at the front of the stable, tack hangs on the walls, and four saddles rest near the wagon. Twelve other stalls stand empty.

If the party tries to question the boy, he tells them very little. He lives nearby, and considers the inn

a nice place to work. He knows the food is good and the rooms are clean. He knows no rumors about Greyhawk and does not seem too bright.

### Your Host, the Hill Giant

The Whistling Fish is owned by Gruenab, a hill giant of small stature by giant standards. Although small for a hill giant, he still towers at a height of nine feet.

**Gruenab, hill giant:** AC 3; MV 12; HD 11 + 1; hp 78; Str 19; Int 10; Wis 8; Dex 12; Con 17; Cha 8; #AT 1; Dmg 2d4 (sword) + 7 (strength); AL CG; THACO 8; age 77.

Gruenab is truly an anomaly. His giantish appearance belies his actual nature. He was the victim of a curse put upon his father, Bozbob, by a witch over 100 years ago. His father was arrogant and boastful beyond measure, and in order to shame him, he was cursed by a witch whom he had annoyed once



en. The witch declared that b's sons would be stunted ave the tendencies and na- of the humans. This was the ate shame for Bozbob, who dered himself superior in way to humans and most gi- He did not believe the witch's , but when Gruenab was Bozbob exiled his wife and son.

enab's mother, Garna, found e with another settlement of , and Gruenab was raised in ays of the hill giants. When reached adulthood, he took of his village and eventually d in Greyhawk. He never felt ough he belonged with the gi- or he was taunted as a child unned as an adolescent. His size and sickly appearance ant standards) made him the of much ridicule by the giants. When he reached awk, however, he found an y different attitude. Here, he epected for his mass and th. He was hired immedi- as a bodyguard for a wealthy ant. Upon the merchant's Gruenab inherited a minor e in reward for his loyalty ffectiveness. He used this in- to build The Whistling Fish. enab's human tendencies aim a pleasant, benevolent sition. Despite the cruelties childhood, he always red friendly and trustworthy. ough his appearance is intimi- g, most people take a quick to Gruenab once they get to him even slightly.

enab is outgoing, friendly, exceedingly loyal to his friends o the city of Greyhawk. After is city has provided him with mfortable lifestyle, good s, and security. He is a ready e of information about awk and directions around y. He does not discuss gossip nors unless he feels the infor- n is accurate.

The inn is staffed by Gruenab, a cook named Fedden, three wait- resses, two cleaning girls, two stablehands, a human female named Harsi, and her 12-year-old son, Willy. Harsi is Gruenab's right hand, and they have the affection of a brother and sister for one another. Harsi was widowed when Willy was five years old. Two years later, Gruenab saved her from a vicious attack. She was walking home late one evening when she was attacked and dragged into an alley. Gruenab heard her screams and came to her aid. Her attackers were dealt the full wrath of a hill gi- ant's anger and Gruenab carried Harsi to the inn to care for her inju- ries. They became friends instan- tly, and Harsi and Gruenab struck upon a plan which pleased them both. Harsi moved into the inn with Willy, and the two of them helped Gruenab run The Whis- tling Fish. Gruenab never ex- pected to have a family, but he plans to leave the inn to Willy when the time comes.

The cottage behind the inn is home to Gruenab, the inn's owner. The cottage is divided into five rooms: four bedrooms and one large sitting room. It is designed to be home to Gruenab, his assistant Harsi and her son, and other em- ployees of the inn who may wish to live there. Gruenab occupies the largest bedroom, Harsi and her son share a room, and the other two rooms may be occupied by other employees at the DM's dis- cretion.

Although the PCs might never encounter Gruenab's room, its de- scription is provided here for con- venience in the event that nosy PCs break in or sneak a look through the windows.

The scale of Gruenab's bedroom is almost comical. All the furniture was custom-built to accommodate his large proportions. The room contains a bed, nightstand, chest of drawers, wardrobe, and a round

table with four chairs. The wooden plank floor is covered by several rugs that appear to be animal skins.

The room contains the typical clothing and personal articles that a bachelor might possess. The room is clean and neat, but nothing unusual or valuable can be found with the exception of a large, flat chest stored under the bed.

The chest is unusually sturdy and is made of wood reinforced with metal bands. The chest is 8' by 4' by 10". A large, ordinary pad- lock is always kept in place on the chest.

The chest holds Gruenab's chain mail armor and sword from his days as a bodyguard. These were purchased by his former em- ployer. Gruenab's size is intimidat- ing in itself, but his employer decided to enhance the image by outfitting him in chain mail and providing him with a two-handed sword. The sword is two-handed size by human standards, but Gruenab wields it easily with one.

The chest holds no other items.

## All the Comforts of Home

You enter the inn through the ten-foot-tall door to find a spa- cious barroom. You feel dwarfed by the large proportions of the entire establishment; the ceil- ings here are twelve feet high.

The perimeter of the room is divided into small alcoves, each of which has its own table and benches. The bar forms a three- sided rectangle, beginning at the right wall and making two square corners until it eventu- ally ends at the same wall from which it began. A doorway and a window to the kitchen are visi- ble behind the bar.

Round and rectangular tables with stools and chairs fill the

too oft  
Bozbo  
and h  
tures o  
ultima  
consid  
every  
ants. H  
curse,  
born,  
infant

Gru  
refuge  
giants  
the wa  
he rea  
leave  
settled  
as tho  
ants, f  
and sh  
puny  
(by gi  
object  
other  
Greyh  
entire  
was r  
streng  
ately a  
merch  
death,  
fortun  
and ef  
come

Gru  
give h  
dispos  
of his  
maine  
Althou  
dating  
liking  
know

Gru  
and ex  
and to  
all, thi  
a con  
friend  
sourc  
Greyh  
the cit  
or run  
mation



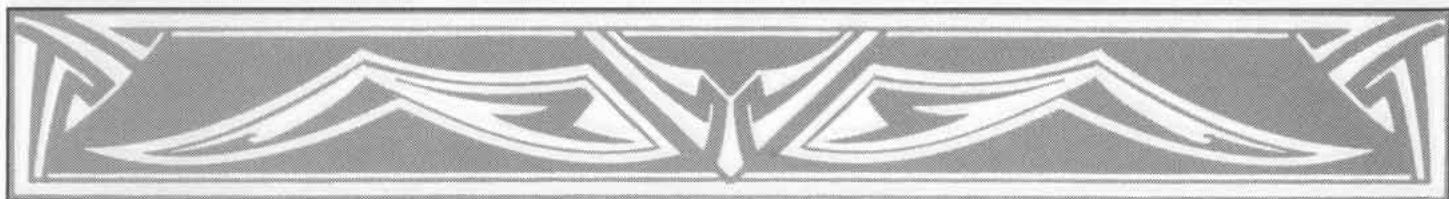

rest of the room. To the right of the bar, a wide wooden staircase leads upstairs. Two fireplaces and two round wood-burning stoves are strategically placed to provide heat to the entire room.

The tavern will become increasingly active as the dinner hour draws near. It is busy during midday, nearly deserted throughout the afternoon, and reaches standing-room-only capacity during the supper hour. After the supper hour, the crowd dwindles to a comfortable capacity.

When the PCs enter the bar, they are greeted by delicious aromas and a cozy (although noisy) atmosphere. Within a few minutes, they will be able to find a table and order supper. The Whistling Fish serves standard fare: stews, soups, roast chicken, mutton, pork, fresh bread, and pies for both a main course and dessert. The food is excellent and reasonably priced.

The waitresses are competent and quick; there are no stunning beauties but none are unpleasant to look upon. They can recite the prices of the guest rooms and direct them to Gruenab to engage lodging. The waitresses can provide 1-2 rumors. Chatter around the bar can provide another 1-3 rumors.

Gruenab can be seen tending bar. When the PCs see him for the first time, the proportions of the bar will suddenly make sense. The waitresses can provide most of Gruenab's history, and they add that working at The Whistling Fish is a position coveted by waitresses since brawls almost never break out with Gruenab there to break up fights. This is one of the safest inns in town.

When the PCs approach Gruenab to engage rooms, he greets them warmly and shakes hands with a surprisingly gentle grip, not the crushing grasp that

might be expected. Gruenab is able to provide lodging for the party at a slightly higher rate than they might hope to pay. Adjust the lodging rate to be appropriate to the financial condition of the party.

The Whistling Fish has a total of eight guest rooms. The largest room holds six beds, three rooms have four beds, and the remaining four rooms have two beds each. In each room, there is one chest of drawers per two beds, a wardrobe, a small table, and one straight-backed chair per bed. The rope beds have been well-used, but are extremely clean. Simple homespun curtains cover the windows, and the doors are equipped with sturdy locks. The floors are bare and creak slightly.

Gruenab will ask one of the waitresses to lead the party upstairs to show them their rooms. Since the rooms vary in size, choose whichever rooms best suit the party's desired sleeping arrangements.

The bar empties around midnight every night. Gruenab doesn't enforce a strict closing time, and sometimes stays open extremely late for special occasions or when good friends are celebrating.

The clientele of The Whistling Fish is a mixture of sailors, dockworkers, farmers, and shopkeepers. Although the group can become boisterous, they are well-behaved. This crowd is similar to any other barroom crowd. The PCs will hear some local gossip about men who are drunkards, cheaters, and hen-pecked husbands. News may arise of an engagement, birth, or death. Dockworkers might discuss their tyrannical boss or an unusual shipment that has recently arrived.

## A Friendly Native

At an appropriate point in the evening, the party should be approached by Talasek, a paladin of St. Cuthbert. He is a friendly local, looking for some company. He also likes to greet strangers and offer advice on the customs and flavor of Greyhawk. He is willing to guide visitors around town, point out sights of interest, and offer advice on places to eat or rent rooms. Eventually, Talasek begins to let slip some curious information. He says things like "Greyhawk isn't the way it used to be," and "You just don't know who you can trust anymore." If questioned, he merely says, "This town used to have laws about certain things. But now, the laws are still there, it's just that no one will enforce them. I never thought I'd see the law turn their back on the lawful citizens and look the other way for the lawbreakers."

In a hushed, distressed voice, Talasek tells you that he senses a growing evil but cannot pinpoint it. "I've been getting this feeling for many months now," he tells you. "City officials seem indifferent to the problem. I can't tell them where I think the problem is, so they just tell me that they can't deal with a problem that isn't there. But I've seen some strange things. We've had some strange folk move into town. They're not the ordinary families or farmers or merchants. They're too quiet and aloof. Sure, there'll always be people like that, but there have been too many lately. They always come alone. And they always seem to find others of their kind. I don't know where they live; I've tried to find them. They just seem to disappear into the city."



"Greyhawk used to see a lot of adventurers like yourselves. But lately, they leave town soon after they arrive. I've heard that their rooms have been ransacked, they've been ambushed, and they've been threatened.

Talasek falls silent for a while, then adds apologetically, "I'm not trying to scare you folks. I thought you should know some of this so you can watch your backs. But I'm raining on your good time, and for that I apologize. I've said too much. Tell you what. Let me show you around the city tomorrow. It really is a great place. I promise I'll be more fun and I'll show you some really interesting things. This city has treasures you won't find anywhere else. What do you say? I'll meet you here right after breakfast."

If the party seems reluctant to go with Talasek, choose one member of the party to be enthusiastic about the tour and convince the others to go. Talasek will ask the names of the party members (if they haven't been introduced already), shake hands warmly, and leave.

If the party members attempt to use spells such as *know alignment* or *ESP*, they will learn that Talasek is telling the truth and is nothing less than sincere.

## The Mysterious Stranger

After Talasek has left, choose a PC randomly or choose the most observant character to notice something unusual. Inform him that shortly after Talasek arrived, he noticed a man enter the tavern. This man found a seat, but changed location several times, each time coming closer to your table. Finally, after Talasek left, the man also left abruptly, leaving a glass of cider that he had just ordered. The man wore dark blue robes and was constantly toying with a piece of jewelry that hung on a chain around his neck. The character will recognize the man if he sees him again. However, until now, he did not consider this important or noteworthy.

The man described here is a spy for the cult of Iuz. He is one of the many clerics who live in the cult's underground complex. The PCs will not encounter him again until they infiltrate the cult.

The encounter with Talasek can take as long as necessary. The PCs can ask him questions about Greyhawk and the countryside. Talasek knows all the geography of the city, the names of the city officials, anyone who is a cleric of St. Cuthbert, locations of all the temples of St. Cuthbert, many local merchants and vendors, and many townfolk. He also knows many rumors, but he doesn't believe any of them. He believes them to be the result of over-active imaginations.

When the PCs finally go to bed, the night will pass uneventfully.

They will hear noises such as singing sailors, drunkards trying to find their way home, an occasional cat shrieking, and random barking, the typical noises of the city.

In the morning, the party will be served breakfast downstairs by Harsi. Gruenab serves breakfast only to guests of the inn, and usually eats with his guests. The other staff of the inn who live on the premises join them.

Inform the PC who noticed the robed stranger that he had some strange dreams during the night.

You dreamt of many robed figures wearing strange symbols on chains around their necks. The figures appeared to be searching for something in a huge, dim cavern. Eventually, one of them found an enormous glass globe which was moved to the center of the cavern. The figures clustered in a circle around the globe and began chanting louder and louder as if their chanting would break the globe. The globe rumbled and shook, but never broke. One of the figures became angry and shouted at the rest of the participants. Then they filed out of the cave, leaving the globe to be guarded by four of the figures.

The PC knows nothing more of this dream, and could not determine what any of the figures were saying. Some of the other PCs might simply blame the dream on too much ale or an overactive imagination.



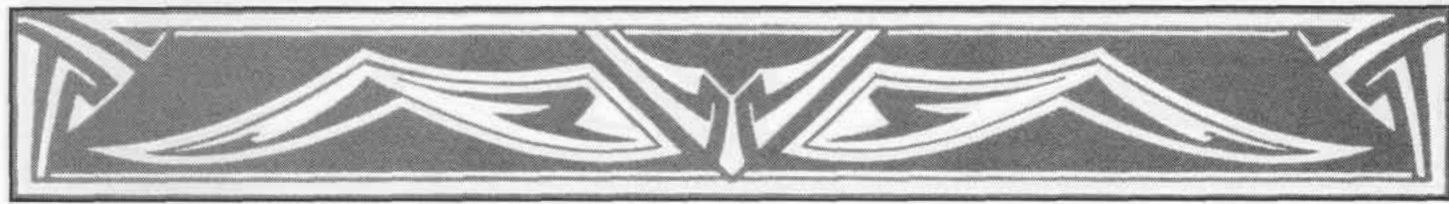

## 2: Something Rotten in Greyhawk

If the party has agreed to tour the city with Talasek, go to Encounter 1. If they declined his offer, go to Encounter 2.

### Encounter 1

Although Talasek seemed enthusiastic and sincere, he does not appear for his tour with the party. Let the PCs wait nearly two hours, or if they decide to go out into the city on their own, stop them just as they prepare to leave the inn. Proceed with Encounter 3.

### Encounter 2

After the PCs have finished breakfast and as they prepare to leave to explore the city, they will hear a loud knock at the door before they have a chance to depart. Make certain that this event occurs before any of the PCs have a chance to leave. Proceed with Encounter 3.

### Encounter 3

After the PCs have waited two hours (or just as they are preparing to leave the inn), four members of the city guard come to the Whistling Fish. Gruenab will answer the knock at the door and begin explaining that the inn is not yet open, but will allow the guards to enter after listening for a few moments. The guards will approach the PCs and ask general questions such as their names, when they arrived in town, where they have come from, and why they are in Greyhawk. They will then ask if the PCs know Talasek and how they came to meet him. Finally, they will inform the PCs that Tala-

sek was attacked last night. He was able to heal himself just enough to make his way to the Temple of St. Cuthbert. There, the clerics were able to heal him further, and the clerics also summoned the city guard. Talasek will recover, but he is still weak and his mind is fogged. The guards are requesting that the PCs accompany them to the Citadel to answer some questions.

If the PCs try to interject while the guards question them, they are hushed rudely and told, "We're the ones asking the questions here. Just tell the truth and there won't be any trouble."

The party will be given time to gather what belongings they may wish to take. Any magic-using members of the group will receive suspicious stares from the guards, since open use of magic in the city is frowned upon.

The guards have a wagon drawn by four horses in front of the inn. It is large enough to accommodate the party and all the guards, and soon they are on their way to the Citadel. The guards do not attempt to tie the PCs' hands or feet unless the PCs become belligerent.

If the PCs should attempt to overcome the guards, make certain that the guards win. This is easily accomplished by adding any number of guards who are conveniently waiting outside and can rush in as the situation warrants. If this occurs, all the PCs will be bound hand and foot for their trip to the Citadel.

If this adventure is not being played in the City of Greyhawk, choose another appropriate site such as a jail or sheriff's office for the following encounter.

### A Visit to the Citadel

If using *The City of Greyhawk* boxed set, refer to the description of the Citadel beginning on page 47, GoF. Lead the wagon up the road and through the Battle Gate. Since the wagon was dispatched earlier and its return is expected, the Citadel gates will be opened without the usual formalities. Once the PCs have disembarked (or have been dragged from the wagon, still bound), they will be led through the Entry Hall to the Office of the Chief Constable. See the description and map on pages 48 and 56, GoF.

Derider Fanshen, the Chief Constable of Greyhawk, is unavailable at the time the PCs arrive. The matter will be handled by her Deputy Constable, Nestor Morden.

**Nestor Morden, Deputy Constable:** AC 1; MV 12; F5; hp 38; #AT 1; Dmg 1d8 (long sword) +3 (strength) +1 (magic); Str 18/60; Int 12; Wis 10; Dex 16; Con 17; Cha 14; AL CE; THACO 14. Equipment: *chainmail +1, ring of mind-shielding.*

Nestor is a tall (6'3"), gangly man. He has black hair and dark, intense, beady eyes. He wears black trousers and a red shirt with a black half-cloak. Black boots rise up to his knees. He walks with a barely noticeable limp.

Nestor appears friendly enough, but choose one member of the party to distrust him for unknown reasons. Inform the chosen PC of his misgivings after the party has left the Citadel. The other party members will have no such feelings.

Nestor is secretly a member of the cult that the PCs will discover. His description as a cult member can be found in the cult description section of this module.

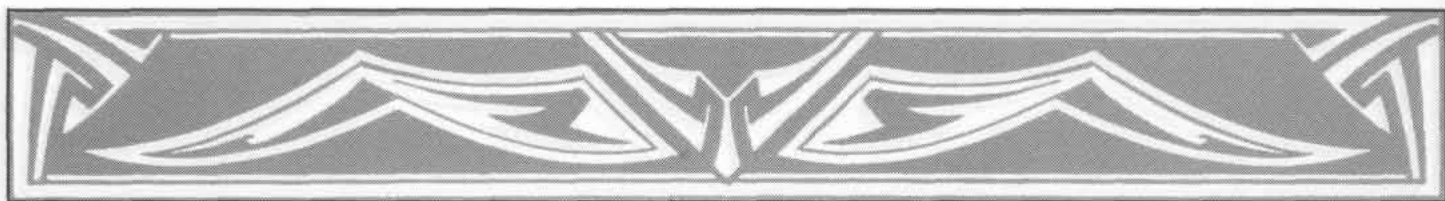

Nestor greets the party somewhat sternly, although politely. He explains that he is only gathering information at this time, and that he is not ready to make any arrests—yet. He then asks the same questions that the guards asked: names, homes, reasons for being in Greyhawk, etc. He also asks how they met Talasek, what they talked about at the inn, and what their plans were for today. Nestor asks what the PCs did after Talasek left the inn; whether they stayed in or went out.

The PCs should not attempt to use magic in Nestor's presence. There is no chance of casting a spell secretly. If a PC does attempt to cast a spell, Nestor becomes angry and reprimands the character.

Ask the PCs to make an intelligence check. PCs who make the check feel that Nestor seems casual enough, but Talasek's attack doesn't strike them as a problem that should attract this much at-

tention to this level of the City Watch. They wonder whether an ulterior motive exists; is Talasek someone special, or does Nestor not trust the party for some reason?

If the PCs try to ask questions of Nestor, he brushes them off by saying, "That's not important," or "This is a matter for the authorities—don't worry about it." He is vague and elusive about any questions the PCs try to ask.

If the PCs mention the man in the tavern who was watching Talasek, Nestor asks for a description, then gets a strange look on his face for a brief moment. He finally lets out a long sigh and says, "That's a poor lie. No, I'm sorry—I don't believe there was any such stranger." PCs get the feeling that this means something to Nestor, but he is hiding something.

As long as the PCs are cooperative, after several hours of questioning, Nestor allows the PCs to leave. He warns them, however,

that no one is above suspicion—especially strangers!

If the PCs try to attack Nestor or any guards, they will be subdued quickly. Enough guards are on duty to overcome the party and see to their cooperation.

If the PCs arrived at the Citadel bound and gagged, Nestor is more harsh, but eventually allows them to leave. If the PCs attack *and* inflict any damage on any guards, Nestor has them thrown into a cell after blindfolding them. They will be forced to wait there until the following day, when one of the priests of St. Cuthbert will come to ask for their release. Invent a suitable evening in the dungeon for the PCs to pass the night. The PCs will be released the next day to the custody of the priest with a stern warning from Nestor.

If the PCs are released without incident, they are told that Talasek is at the Temple of St. Cuthbert. Any of the guards can provide





directions. Encourage the PCs to go there to discuss the attack with Talasek if they are reluctant. Proceed with Encounter 4.

If the PCs are jailed and later bailed out by the priest, he asks them to accompany him to the temple to discuss what happened. Proceed with Encounter 4.

## Encounter 4

### The Sacred Temple of St. Cuthbert

Located in one of the wealthiest quarters of the city, this is the busiest temple in Greyhawk. St. Cuthbert boasts more followers than any other deity worshipped in this area. The temple is large and beautiful and is never at a loss for monetary support. Its many clerics are strong and unified.

The temple is built of white marble and is topped by a roof of polished copper whose gleam can be nearly blinding on sunny days. The combination of the shine from the roof and the white marble give the temple a visage of holy power and strength. It is an awesome sight even for non-believers.

Read the following section aloud to the players. If they have been bailed out and accompanied by a priest, omit the section describing the PCs' wait in the shrine, but read the details of the shrine's amenities.

A wide courtyard spreads in front of the temple. Paths of white tile lead through well-kept gardens of roses, exotic flowering plants, and evergreen shrubbery. Mistletoe and holly grow profusely.

The paths lead to a circular fountain. In the center of the fountain, on a pedestal high above the water, stands a magnificent eight-foot statue of St. Cuthbert, carved of white mar-

ble. The entire garden is one of the loveliest you have ever seen.

Several clerics dressed in reddish-brown robes tend the plants, pruning and watering them. Two clerics stand in front of a rose bush, discussing which blossoms should be cut to make up an arrangement for the shrine for the next Godsdays.

The white tile paths eventually lead to the enormous double doors of the shrine. The doors are built of a pale, dense wood, and are bound with brass scrollwork. The doors are open and lead directly into the enormous room of worship.

This room looks capable of seating 600 persons. Many rows of straight-backed benches face the front of the rectangular room. Huge white marble columns support the 50' high ceiling throughout the room. Paintings of scenes from St. Cuthbert's life line the side walls. The ceiling is painted to represent a heavenly blue sky filled with white clouds and a blazing sun. Underfoot, the floor is built of polished tiles of deep green marble.

It should be obvious to the PCs that this temple was constructed at great expense. Despite this show of wealth, there are no temple guards visible.

After a few moments of looking about the shrine, a brown-robed cleric approaches the PCs, and in a soft voice asks if he may help them. When the PCs respond that they are looking for Talasek, he says, "And who may I say is inquiring?" Once the PCs have introduced themselves, he replies, "One moment, please. I shall learn if he is accepting visitors." With that, he exits through the double doors.

The PCs are again left alone. They have time to examine the temple further before he returns.

As they look around, the PCs will learn that no expense has been spared in decorating or outfitting the church. Every candlestick and sconce is made of gold and decorated with silver. The pulpit appears to have been hand-carved from one solid block of a rare wood. The chairs used by the priests at the front of the shrine are carved of the same rare wood and bear white velvet cushions. Fine tapestries as high as the ceiling and ten feet wide decorate the front of the shrine, depicting various scenes from nature. Everything is tastefully decorated, using only the finest materials.

The cleric will return shortly, saying "Master Thraydin will see you. Please follow me."

He leads you out the double doors and around the side of the shrine. From your observations inside and now outside the building, you guess that it holds only the shrine and no additional rooms.

You follow another white tile path around the shrine. Ahead, you see another white marble building that lies at a right angle to the Temple. This building is rectangular, but appears to have three floors. You notice double doors on the front and side of the building. The windows are small but numerous. The cleric leads you through the doors in the narrow front of the building. These doors appear identical to those at the front of the shrine.

You enter through these doors and find yourselves in a large foyer. The floor is pink marble, and the room is furnished comfortably, but without the grandeur of the shrine. The cleric leads you up a pink marble staircase to the second floor.

The staircase opens onto a long hallway. At least twenty

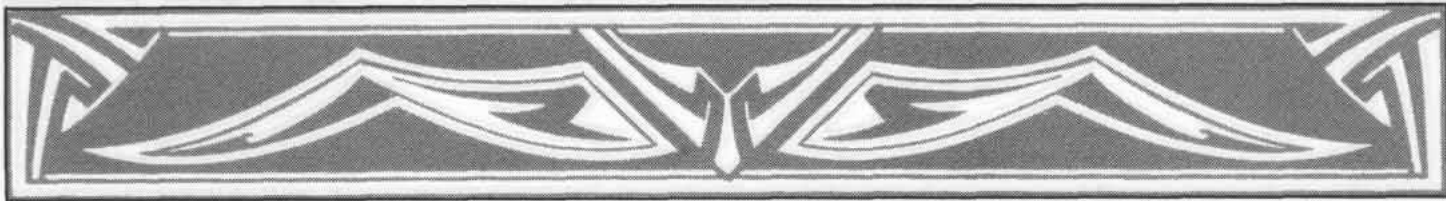

doors can be seen down the hall. The holy symbol of St. Cuthbert appears on every door. The cleric leads you to the fourth door on the right and steps aside, motioning for you to enter.

Inside, you see four beds, lined up with their heads against the outside wall. A holy symbol hangs above every bed. Two of the beds are empty, and a pale, elderly man occupies the third. You immediately recognize Talasek as the occupant of the fourth bed. He is sitting up, and smiles broadly as you enter. His smile fades quickly, however, as he begins to apologize for "dragging you into this."

Talasek is truly sorry for getting the PCs involved in his troubles. He apologizes for their audience with the constable. If the PCs spent the night in the dungeons of the Citadel, he is gushing with apologies and is practically on his knees begging for their forgiveness.

At last, when Talasek has finished apologizing, the PCs can finally begin to get some information from him about his attack.

### Talasek's Story

"After I left the Whistling Fish, I started heading home along my usual route: up the Processional, then down the side street to my house."

In Talasek's attack, once he had succumbed to the *bewilder* spell, he was beaten by three of the cult's warriors. A mage directed the attack and signalled the warriors, who wore robes to conceal their identities, armor, and weapons.

If the PCs mention the stranger who watched them in the Whistling Fish, Talasek has a vague recollection of him. He remembers the man, but did not pay much attention to him. His robes were similar to those worn by Talasek's

hands as if to lower his hood, then I was struck on the head from behind.

"I remember falling to the ground and being kicked all over by hard boots. I could see three men in robes beating me, and the other man, the one I saw first, just standing there, watching. I felt as if I couldn't move; I tried to fight back but I was just swinging at the air, as if I had never fought anyone in my life.

"Finally, the first man made a hissing noise and the beating stopped. The three men followed the other off into the darkness.

"I don't know how long I lay there, but it felt like forever. I still didn't know where I was, but I knew my name and I knew that I had come from the Whistling Fish. I knew that I was trying to find my way home.

"I began to pray to St. Cuthbert, and gradually, my memory returned. I continued to pray and eventually I felt well enough to make it to the Temple. I was lucky when I passed through the Garden Gate that the guards didn't notice my injuries. If they had known I had been beaten, they would have dragged me to the Citadel for questioning immediately. Unless you talk to Derider Fanshen herself, the guards tend to forget that injuries need attention before they hear your story. I longed for the comfort of this

side street to my house. I was within 100 yards of home when suddenly I felt lost, as if I had never been on my street before. I started to look around for anything familiar, but things just looked stranger and stranger.

"As I turned around, I noticed a man in a robe walking toward me. I couldn't see his face, but I asked him if he could help me because I suddenly seemed to have lost my way. He raised his

tries to answer any questions they have. However, he did not see the faces of any of the men who attacked him, and only remembers seeing their robes.

**DM's Note:** Talasek's attackers were members of the cult of Iuz. They have been watching him for several months, realizing that he could be a potential problem. The cult has restrained from killing him however, because murders bring investigations and the cult cannot afford the risk of being discovered, even with their agents in the Citadel to throw suspicion away from the cult.

The attack was ordered after the cult's spy observed his conversation in The Whistling Fish. The cult decided to send Talasek a message to mind his own business, except the beating did not serve to define that message very clearly.

Talasek's attack began with a *bewilder* spell, which is described in the New Magic Appendix at the end of this module. Briefly, the victim of a *bewilder* spell suddenly finds himself lost and unable to recognize any of his surroundings. Regardless of the familiarity of the surroundings, the victim does not recognize anything and will find himself wondering how he arrived at his present location.

The cult's thugs like to use this spell to slow down their enemies, allowing time to close or improve their attack position.

"I had to go to the shrine, for the care of the priests. In the event that they couldn't heal me, I wanted to be close to St. Cuthbert's favor."

Talasek also tells the PCs that he is going to be fine, but the priests want him to rest a few days. He is ready to leave now, but he respects the priests and has agreed to stay in bed until tomorrow.

Talasek is strong enough to help the PCs as long as they wish





attackers, but those robes are fairly common in Greyhawk.

It is possible that the man had a connection to the attackers, but Talasek feels that the association is not strong enough to warrant suspicion. He is adamantly against possible false accusation.

If the PCs mention the pendant that the stranger in the bar wore, he suddenly has a memory of a flash of silver while he was beaten. He remembers that one of his attackers wore some kind of a symbol on a chain around his neck. He is certain he had never seen the symbol before, but his mind is too foggy about some of the details of his attack to remember the symbol with any degree of accuracy. Even if he is shown a picture of the symbol, he still is not certain whether it is the same one he saw on his attacker.

Suggest to the PC who dreamt of the robed figures that the dream might have significance in light of these developments, if he hasn't thought of this already. The PCs can discuss this at length, if they wish, but they come to no concrete conclusions.

The encounter with the Deputy Constable and the discussion with Talasek will keep the PCs busy into the late afternoon. Talasek will then ask the PCs if they would mind performing a small favor; he needs a few items from his room at his boarding house, and he is hoping that the PCs would not mind fetching them. When the PCs are ready to depart, Talasek rings a small bell at the side of his bed. Another brown-robed cleric appears to show the PCs out of his room.

If the PCs are reluctant to run the errand, encourage them to go in some way. Possibly one of the PCs has taken a strong liking to Talasek. A female PC would be a likely candidate—remember, Talasek is a paladin. Otherwise, some of the PCs could simply feel sorry for Talasek and see nothing wrong in performing this small favor.

## Encounter 5

Talasek lives in a modest boardinghouse on a side street off the Processional. The back of the boardinghouse faces the wall which divides the High Quarter from the New City. The boardinghouse has four rooms designed for single occupants on the ground floor, and three rooms for two occupants on the second floor. Talasek's room, on the first floor, is at the rear of the building and offers a panoramic view of the city wall.

Talasek has given the PCs directions to the boardinghouse and instructions for entering his room, as well as a list of the articles he needs. He warns the PCs that housekeeping is not his strong suit and that the room might be somewhat disorderly.

The PCs will have no trouble finding the boardinghouse. Since the landlord does not live on the premises, no one stops them as they enter Talasek's room.

As you enter Talasek's room, you realize that he was not joking when he said the room might be disorderly. Clothing is strewn everywhere, books litter the floor, and nothing seems to have a proper place. But as you look at the room, you realize that the dresser drawers are empty and the shelves have been cleared. Talasek isn't just messy—his room has been ransacked!

Allow the PCs to decide whether to search the room for clues, to look for the items Talasek wanted and return to him, or to leave the room undisturbed. If they decide not to return to Talasek until tomorrow, remind them that he will worry about what may have happened. Encourage them to return to him right away. All of the items on his list are still in the room and may be collected.

If the PCs wait until the next day to look through the room, nothing has changed. The culprits did not return overnight, so no evidence was destroyed.

When the PCs look through the room, they find that every inch has been searched. Drawers are overturned, pockets are turned inside-out, and the mattress has been sliced open. Whoever tore apart the room did a thorough job.

The lock on Talasek's door shows evidence of being picked. Both windows are closed and do not appear to have been disturbed.

When the PCs return to the shrine, they may head directly for Talasek's room. They will be stopped on the stairway by a cleric, who offers assistance. When the PCs explain their mission, the cleric will accompany them to Talasek's room, but he will depart when Talasek gives his approval.

Talasek is naturally alarmed to hear of the break-in. His first concerns are that his landlord's property was not damaged and for the items he wanted. He shows great relief when the PCs provide all the items he wanted: some clothing, a small portrait of his father and mother, and something that looks like a carved block of wood. The wooden object looks like nothing more than a paperweight, but Talasek shows that by twisting the block correctly, it opens to reveal a small, hidden chamber. Inside is a woman's ring. He tells the PCs that it is the ring that his father gave to his mother on the Bridge of Entwined Hearts on the night they were betrothed. (Talasek's parents are both dead; see his character description in the appendix for details.) Talasek has saved it for sentimental reasons and plans to give it to his wife someday, once providence has selected a woman for him.

If the PCs ask, Talasek will tell them that the Bridge of Entwined Hearts is the bridge crossing the



Millstream in Clerkgurg (p. 70, GoF). Legend tells that marriage proposals made on this bridge will result in lifelong unions. It is possibly the most romantic place in town. Talasek sighs softly as he closes the ring back into its box.

The PCs and Talasek can discuss the details of the robbery or clues the PCs may have found. They come to no real conclusion, but feel certain that the stranger in the tavern, the attack on Talasek, and the robbery are all connected. They have no idea what the motive behind these events may be.

Talasek wishes the PCs to accompany him back to his room the following day, and asks if they will meet him at the shrine after breakfast. They can finish searching for clues in the morning, since Talasek will know best if anything is missing.

**DM's Note:** The room was ransacked by members of the cult to serve as an additional warning to Talasek. They were also looking for anything valuable to add to the cult's coffers, but found nothing. A mage assisted in the ransack, casting *detect invisibility* to assist the search, but nothing was to be found. The cult had also hoped that a robbery might give Talasek something to do other than track down the cult, but they found nothing suitable to steal.

## Encounter 6

Speaking with Talasek should carry the PCs well into the supper hour. Regardless of the way the PCs spend their evening, a message awaits them when they return to The Whistling Fish. Gruenab received the message late in the afternoon from a small boy who appeared at the inn. He did not take notice of the child, and had never seen him before. The PCs will have no way of finding the boy. Although Gruenab guessed his age to be about eight years, it

will be impossible to find the child in this large city without a better description. If the PCs ask Gruenab to observe any future messengers, he is more than willing to oblige and promises to keep his eyes open in the future.

The parchment Gruenab hands you has been folded in thirds, and a plain drop of red wax without a seal holds the page closed. The message is written in ink on the small sheet. It says simply, "Leave the city if you do not wish to be harmed. Stay, and you risk your lives." It is not signed.

**DM's Note:** The message was sent by the cult, but the PCs have no way of determining this. The cult deliberately used red sealing wax to throw the PCs; had they used a black seal, the PCs would probably have guessed the note to be from an enemy, and had they used a white seal, they would have probably guessed it to be from a friend. A red seal offers little room for speculation.

If the PCs spend their evening questioning patrons of the tavern or other residents of Greyhawk about the robed men, no one has seen them. None of the employees of The Whistling Fish recall them. Gruenab remembers the man who was in the tavern on the previous evening, however. He did not notice the stranger's activity of changing tables, but he remembers serving the man several glasses of cider. He also noticed the pendant the man wore, and describes it to the PCs.

The pendant looked similar to a fork with three tines. Instead of the tines being parallel, however, the outer two tines diverged at a sharp angle from the center tine. Gruenab is able to provide a crude drawing. It does not have any significance to him, and he has never seen anything similar before.

The PCs will learn nothing further this evening. No one has seen or heard of the robed men or the pendant.

The night passes as uneventfully as the PCs' first night in Greyhawk. The PCs have little difficulty sleeping, and no one has any unusual dreams.

The next morning, the PCs can once again join Gruenab for breakfast before setting out for the temple. Nothing unusual happens during breakfast or on the way to meet Talasek.

Talasek is waiting, awake and eager to go home from the shrine when the PCs arrive. He is glad to see them and is thankful that they were willing to escort him home.

Talasek is no worse for his attack. He has regained his strength and is surprisingly cheerful for a man who was attacked and robbed. His faith in St. Cuthbert is deep, however, and he will tell the PCs that somewhere, a reason exists for his misfortunes. It is simply not his place to question the plans of the higher authorities. If St. Cuthbert meant for this to happen, it was with good reason.

Talasek's room is exactly as it was when the PCs left it the previous day. No one has returned.

Talasek can quickly determine that nothing is missing. Whatever the thieves were looking for, they did not find anything. Talasek owns nothing of great value; he donates a large portion of his income to the shrine. He keeps no large sums of money in his room, only enough for daily expenses and his weekly rent (which is paid in full for the next eight weeks). He owns no jewelry except the well-concealed ring described earlier.

The most valuable of Talasek's possessions are his armor, shield, sword, and the small portrait of his mother and father. The portrait has only sentimental value. His armor, sword, and shield are family heirlooms and are worth a great



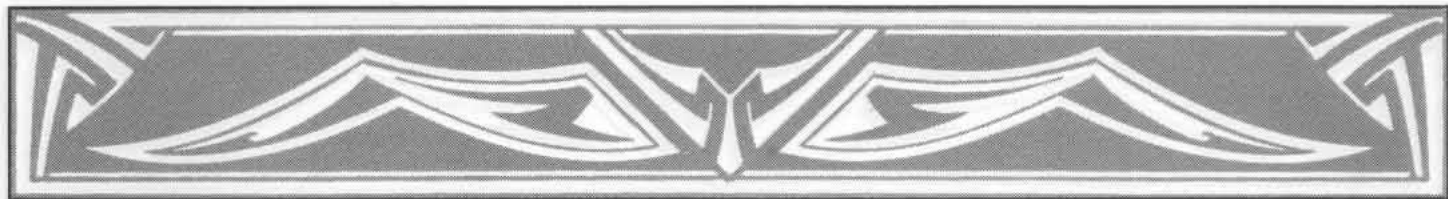

deal of money for their quality alone. He wisely stores these in a vault deep inside the temple. He is free to request these any time he wishes, and the clerics always retrieve them for him in a matter of minutes. (See the description of Talasek at the end of the adventure for details of these items.)

Talasek is at a loss to determine why anyone would ransack his room. He has no enemies that he is aware of and owns nothing of value. No warning was left. Talasek is willing to dismiss the assault as a practical joke, or at least something unrelated to their present difficulties.

As the PCs help Talasek tidy his room, Talasek makes a discovery. Near the window, he finds a tiny patch of white powder on the floor. Knowing that he owns no such powder, he shows it to the PCs. Any mage in the party will be able to identify it as talcum powder, one of the material components for the *detect invisibility* spell. Whoever ransacked the room must have used the spell to learn whether Talasek had anything hidden invisibly in his room.

No other clues exist in the room.

The PCs have some investigating ahead of them. They need to find out who attacked Talasek and why, who sent them the message at The Whistling Fish, and who ransacked Talasek's room. They also should be looking for the stranger in the dark blue robes, and by this time they should have heard several rumors that need to be confirmed. If the PCs need direction at this point, allow them an Intelligence check and give them this "grocery list" of problems they must solve.

**DM Note:** During the evening after the PCs escort Talasek home, be certain to play them through Encounter 4.

## Encounter 7

If none of the PCs suggest it, have Talasek suggest that they investigate the marketplace to find out whether one of the merchants made the pendant that Gruenab identified. They can also investigate other parts of the city for other potential clues with Talasek as a guide.

Use the City of Greyhawk boxed set to move the PCs around the city. Point out sights of interest such as the mansions in the high quarter, the colleges, the city arena, and the burned section of town. Allow them to tour both the high market in the High Quarter and the low market in the center of the New City.

The PCs will have three important encounters while exploring. Play these in any order as appropriate. Also, provide them with two rumors and Rumor #10 from the rumors table.

1. As the PCs round a corner, one of them spies a figure wearing a dark blue hooded robe rounding another corner, away from the PCs. If the PCs do not give chase, have Talasek take the lead. They can easily overtake the figure, and when they confront the stranger, they will discover an elderly woman on her way home from shopping. The PCs frighten her out of her wits, and she begins shrieking for the city guard. If the PCs begin apologizing and helping her gather her dropped purchases, she calms down quickly, before any guards arrive. If the PCs explain the mistaken identity, she catches her breath and finally begins to walk away, looking like someone who had just seen a ghost. She will *not* allow the PCs to escort her home.

2. The PCs spot a figure in a dark blue hooded robe. If the PCs do not give chase, Talasek will take the lead. The figure disappears without a trace. The PCs have no chance of finding the stranger.

3. The PCs (or Talasek) should begin inquiring at the jewelry booths in the market for a metalsmith who created the mysterious pendant. The first three or four inquiries should be met with honest answers of vendors who do not recognize the pendant. At one booth, however, the PCs will encounter a vendor who is not telling the whole story. His first reaction to the PCs inquiry will be, "Who wants to know?" They have found Goldie, the jeweler, who makes the pendant.

**DM Note:** Do not reveal this information to the players! Pendants are worn by members of the cult of Iuz to signify their status in the cult. The pendants vary slightly to signify the status of the wearer. The jeweler knows that these pendants are meant to be a secret; he finds it strange that someone should walk up to him on the street and ask about the pendant. At first, he is confused; the PCs obviously know of the pendant's existence. Does this mean that he can discuss the matter with them? Despite his obvious confusion, the jeweler decides that discretion is the better part of valor and decides to keep his mouth shut.

Regardless of what the PCs say, the jeweler will not blow his cover. They will note his confusion, however. If the PCs attempt to use an *ESP* spell, they will determine that the pendants are made for a stranger as a special order. He thinks the stranger is not a resident of the city, since Goldie never sees him anywhere but the market. The stranger requires four variations of the pendant, pays well, and has told the jeweler that he must never use the design for other jewelry. Goldie must never tell anyone about the orders or he will lose the stranger as a customer. This is all the information Goldie knows about the pendants.



## 3: The Plot Thickens

By now, the PCs should have many clues to pique their curiosity and put them on the trail to discovering that an evil cult is at work in the city. Allow them to investigate in any manner they choose, questioning residents and merchants or generally observing their surroundings. They should also be attempting to verify the rumors that they have heard.

After the message and ambush which follow, events begin happening more quickly. Make certain you are familiar with the remainder of this adventure in order for things to run smoothly.

### An Urgent Message

This event must take place on the evening of the day that the PCs escorted Talasek home from the shrine, for maximum effect.

After a busy day of investigating, the PCs finally get to their rooms at The Whistling Fish and fall asleep. Sometime during the wee hours of the morning, while it is still very dark, the PCs are awakened by a loud knock at their door(s). Gruenab has a message for them that he received only a few moments earlier. It was delivered by a man wearing a reddish-brown robe who said the message was an emergency.

If the PCs do not remember that the clerics of St. Cuthbert wear robes of the color Gruenab just described, allow them an Intelligence check to remember.

The message Gruenab hands you is a written on a parchment scroll tied with a white silk ribbon. It states: "Talasek has been attacked and is near death. His

future lies with St. Cuthbert now. He has asked for you and says he has information that is a matter of life and death. Come immediately. He may be with St. Cuthbert soon."

If the party considers splitting up, encourage them to stay together. Impress upon them the urgency of leaving immediately, but suggest that they take any possessions they feel they might need.

The fastest route to the Temple is directly up the Processional and through the Garden Gate. Once on the other side of the Gate, they can dash across the lawns (since no one will see them at this hour) rather than taking the proper roads.

**DM Note:** Do not reveal this information to the players! The PCs have been sent a phony message by the cult members. Their inquiries around the city and their association with Talasek has drawn the attention of the cult. Since the warning message obviously had no effect, the cult has decided to take stronger action. No emergency exists, but one will soon; the PCs are about to be ambushed!

You shiver as you exit The Whistling Fish and step into the night air. A chilly breeze takes your breath away after giving up the warmth of your beds. A quarter moon provides little light; you must depend on the torches and lanterns you carry to light your way. Fortunately, you are not too far from the Processional, and once there, the route should be easy.

The sleeping town offers no sounds for company. Even the

drunks and sailors have found sleep. The houses are all dark; some of the inns are lit by single lanterns. The city that bustles with activity during the day is governed by an eerie silence at night.

Ahead, you see the Low Market. A few snores can be heard from the tents and gypsy wagons of the vendors. You easily make your way through the market and begin to head up the Processional.

### Ambush!

The party is about to be ambushed by some of the cult members who are waiting for the PCs in the sewers. They wait until the PCs have passed the sewer opening on the Processional. Their first action will be to have their mage throw a *bewilder* spell. Ask for saving throws vs. spell from each character at -2 penalty. If any of the PCs miss their saves, read the following boxed text. If *all* the PCs make their saves, announce the ambush and eliminate the *bewilder* spell.

You're about 100 yards past the marketplace when suddenly none of you can remember why you're here. What are you doing on the street in the middle of the night? You don't recognize your surroundings and you're not sure where you came from.

As you stop to discuss this problem and try to decide what to do next, your party is attacked by a band of hooded men.





The cult has sent this troupe to deliver a message: Get out of town! The attackers comprise one mage, two fighters per PC, and two thieves (one of the thieves delivered the message to Gruenab). Use Barsin and Romar in the battle and as many of the other fighters as necessary to bring the total to two fighters per PC.

When the PCs are in position, Raffel casts *bewilder* (see New Magic at the end of this module) on them to slow them down and allow the fighters to get into position.

Once the fight begins, the thieves will position at opposite ends of the fight to serve as look-outs. When they hear the City Watch approaching, they pass the word and open the entrance to the sewer so everyone can make a clean, quick getaway.

Raffel, human 8th level mage: AC 2; MV 12; hp 20; Str 12, Int 17, Con 8, Cha 10; #AT

1; Dmg by weapon type (staff, dagger + 1); SA spell; SD none; AL CE; THACO 18. Spells: *burning hands*, *magic missile*(x2), *shocking grasp*, *blur*, *detect invisibility*, *spectral hand*, *stinking cloud*; *hold person*, *lightning bolt*, *vampiric touch*; *confusion*, *minor globe of invulnerability*. Equipment: *bracers of defense AC 4*; *wand of paralyzation (6 charges)*; *potion of healing (1 dose)*; *ring of invisibility*. Raffel wears a dark blue robe with the hood pulled up and soft boots.

Barsin and Romar, human 7th level fighters: AC 1,-1; MV 12; hp 63,52; Str 18,16, Int 11,14, Wis 10,13, Dex 13,15, Con 16,13, Cha 10,16; #AT 3/2; Dmg 1d8 (bastard sword +2, long sword +3); AL NE; THACO 12,11. Equipment: *chain mail +2*, *chain mail +3*; *shield +1 (each)*.

Barsin and Romar have been partners for many years. Barsin is the huge, brawny member of the leather armor and shield.

duo while Romar is the more intelligent, agile member. Romar normally plans their attacks and Barsin carries them out to the letter.

Jaffee, Mendel, Sorum, Smykal, Torval, Human 5th level fighters: AC 3,3,4,4,4; MV 12; hp 42,40,37,35,30; Str 15,15,17,13,14, Int 10, Wis 9, Dex 14, Con 14, Cha 8,9,10,11,12; #AT 1; Dmg 1d8, 1d8, 1d8+1 (battle axe +1), 1d6+2 (mace +1), 1d8; SA none; SD none; AL NE; THACO 16,16,15,15,16. Equipment: *chain mail +1* and shield; chain mail and *shield +1*; chain mail and shield; chain mail and shield; chain mail and shield.

3rd level Fighters: AC 6; MV 12; hp 22; Str 14, Int 10, Wis 8, Dex 12, Con 13, Cha 12; #AT 1; Dmg 1d8; SA none; SD none; AL NE; THACO 18. Equipment: *studded*

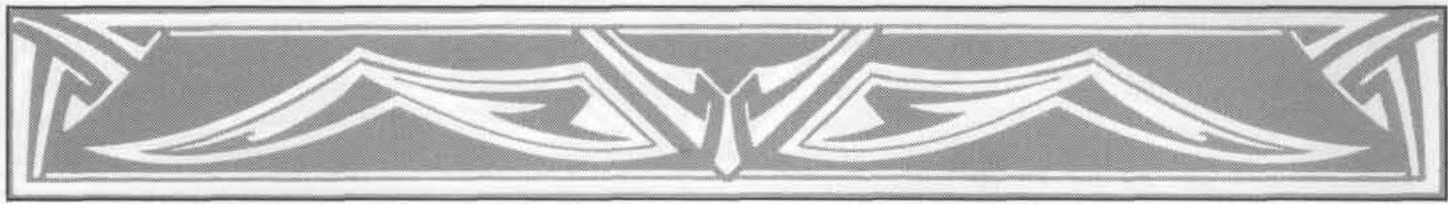

2nd level Fighters: AC 7; MV 12; hp 15; Str 13, Int 9, Wis 8, Dex 12, Con 13, Cha 11; #AT 1; Dmg 1d6; SA none; SD none; AL NE; THACO 19. Equipment: leather armor and shield.

Nimhbell and Slick, human 4th level Rogues: AC 5,5; MV 12; hp 16,15; Str 12,13, Int 15,14, Wis 9,10, Dex 16,17, Con 13,12, Cha 8,12; #AT 1; Dmg 1d4 (*dagger +1, dagger +2*); SA backstab; SD none; AL NE; THACO 18,17. Equipment: leather armor and *ring of protection +1*; leather armor and *ring of jumping*.

The battle should rage for at least four rounds before the City Watch approaches. Lights will be lit in some of the nearby homes. If any of the PCs are at risk of dying and you wish to save them, the City Watch can approach more quickly. Conversely, if the PCs have not taken much damage, the City Watch can arrive more slowly to allow the PCs to take a worse beating. The PCs should get the idea that they may have been slaughtered if the City Watch had not arrived.

The attackers will make a clean getaway. If any of their comrades have fallen, they will efficiently gather the bodies and spirit them away.

Due to the intensity of the battle and the hoods worn by the attackers, the PCs have no opportunity to see the faces of the cult members. Even if a PC announces that he is attempting to remove the hood of one of the attackers, he is too busy defending himself to complete the effort.

The PCs have the option of making a run for cover or waiting to tell their story to the constables. The decision of whether the PCs get away is left to the DM's discretion. The results of either choice are detailed here.

If the PCs run away: If the DM

chooses, the PCs may hide rather than face the City Watch. They will be forced to hide for at least one hour while the guards search the area for the perpetrators. Severely wounded PCs may find themselves in trouble if they do not receive proper attention for their wounds quickly enough.

If the PCs wait for the City Watch: The PCs will be escorted to the Citadel for questioning. Their behavior is very important here. As long as they are cooperative, the guards will release them after questioning (probably around mid-morning). The PCs may need to demand medical attention if the guards "forget" about this detail.

If the PCs become surly or abusive, they will be kept at the Citadel until mid-afternoon and questioned repeatedly. Eventually, the PCs may be charged with disturbing the peace. If they pay a fine (DM's discretion or use the guidelines on p. 11, FFF) they are free to leave.

If the PCs attempt to hide but are caught by the Watch: Use the previous information, but the PCs will face a heavier fine and will not be released unless Talasek or one of the priests from the Temple is summoned to escort them. The PCs will be released to the custody of the Temple. They will again face Nestor, who suggests politely that they leave the City of Greyhawk.

Once the PCs are free of the Citadel, they have several choices. If these do not occur to the players, allow the PCs an Intelligence check for some inspiration.

1. The PCs may go check on Talasek (if he was not needed to bail out the PCs). He is in perfect health and had nothing to do with the message.

2. The PCs may ask at the Temple about the message. No one at the temple was responsible for the message. If the PCs need to be healed, the clerics offer their assistance.

3. Since everyone who passes through a city gate must sign the register, the PCs may go to the register at the Garden Gate to determine whether anyone from the temple passed through the gate shortly before the message was delivered. There is no such entry; the last temple member to pass through the Garden Gate was headed *into* the High Quarter around sundown.

4. Somebody is serious about driving the PCs out of town. Last night's attack proves that someone is worried about the PCs' investigations and wants to put a stop to them.

The PCs now have many leads to follow. Use the descriptions that follow to play the PCs through the various areas of the city that require investigation.

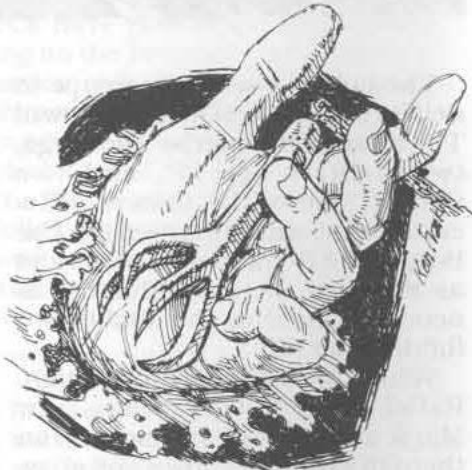





# 4: Shacktown

The cardboard foldups included in this module represents Shacktown. The DM should assemble them as an aid to adventuring in this chapter.

Read the following description of Shacktown carefully before the PCs begin their adventures in this section of town. Keep in mind that the people who live here are the poorest folk in the City of Greyhawk. They are not necessarily evil, nor are they criminals, although some do dwell here occasionally. The people who are permanent residents here are simply poor, good folk, and a certain nobility exists among them. They never steal from one another, no matter how desperate they become. In fact, there is a strong sense of community among these folk, and when one of their kind is down on his luck, the others pitch in to help in any way they can.

Criminals do appear here from time to time, usually when they are hunted by the law. The City Watch almost never comes to Shacktown. It is an excellent place to "disappear." Thieves, assassins, those who owe gambling debts, and those who need to "lie low" come here to hide.

Approximately 500 persons live in Shacktown. This number includes some families, but the majority of the folk here are loners. A few of Shacktown's residents have jobs in the city or on the docks, but most of the residents gather what they can from the forests and the river for their food and essentials. They trade among themselves frequently, since there are no businesses in Shacktown.

The only shrine in Shacktown, a shrine of St. Cuthbert, doubles as a mission. Its priest, Nicholi Nortoi, collects donations of food, cloth-

ing, and blankets from the large shrines in the city and distributes what he can to the residents here.

Shacktown's "buildings" comprise huts, tents, lean-tos, and shanties. Perhaps 10 frame structures exist, and a few buildings are built up from the stone foundations of structures long ago burned to the ground. In heavy winds, at least ten percent of Shacktown is blown away completely.

The streets of Shacktown are little more than dirt paths. In dry weather, they are hard and cracked with deep ruts. During rainy weather, they become nearly impassable due to the mire.

Shacktown is noticeably absent of animals. Dogs and cats are not found anywhere; there is barely enough food for the people who live here, much less anything to be spared to feed a pet. A few chickens can be seen around some of the shanties, and a few nanny goats are kept for their milk.

## Random Encounters in Shacktown

20-sided die roll	Encounter
1-5	PCs approached by beggars
6-7	Randomly chosen PC falls in the mud
8-10	Stranger tries to sell something to PCs
11	PCs chased by senile old woman
12-15	PCs asked to help repair a shack
16-19	PCs told "Go home! The end is near!"
20	PCs get the feeling of being "watched"

## The Humble Shrine of St. Cuthbert

This shrine is one of the few two-story buildings in Shacktown. It is also the best-kept building, since it must serve as a safe shelter in times of bad weather or disaster. It is maintained by Nicholi and anyone who volunteers.

The shrine appears to have been a frame structure at one time, but now it is patched with various sizes of wooden planks. Although ramshackle, it does look as if it could withstand heavy winds. The shrine has lost pieces of its roof and walls in previous storms, but it has always survived more or less intact. A few of the windows still have glass, but these are covered by a lattice of wooden slats to protect the glass from flying debris during a storm.

The shrine is approximately 30' wide and 40' long. Most of the building is whitewashed, except for the most recently repaired sections. Double doors open from the street into the rear of the gathering room. A plain wooden wall running the width of the structure, five feet in from the door, serves as a windbreak for the rest of the room. Doorways cut into this wall on both ends allow access to the gathering room.

The first floor of the shrine serves as the gathering place for worshippers. It holds wooden benches that seat approximately 50 persons, a battered pulpit, and a wooden holy symbol of St. Cuthbert which hangs on the wall behind the pulpit. Simple candleholders stand in front of the pulpit, and sconces line the walls at five-foot intervals. This room is remarkably clean considering the

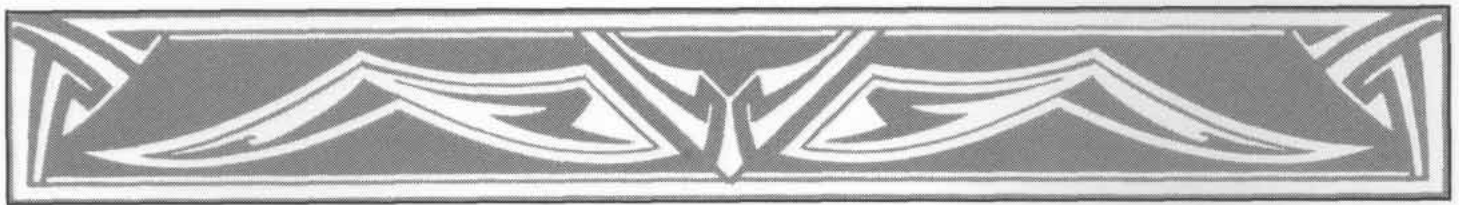

ing of value in this room. The room is only four feet wide, but it runs the width of the building. Enough space exists to hide several persons if the need ever arose.

### Nicholi's Home

Behind the shrine is a small shack that is home to Nicholi. The shack is 10' by 20', and has only one window and one door. Inside, the space is divided into two halves by a wide curtain. The rear space is just large enough to hold a cot and a small chest of drawers. The front room has a worn carpet over its bare wooden floor, three straight, wooden chairs, and several large pillows. A fireplace fills most of one wall, and some cook-

and after services, and around Shacktown the rest of the time. On Godsdays, after the midday meal, he visits the shrines in the city to collect any donations that have accumulated during the week. He also makes trips into the city as needs arise.

Nicholi Nortoi, 3rd level cleric:  
AC 10; MV 12; HD 3; hp 13; #AT 1;  
Dmg 1d6 + 1 (mace); Str 13, Int 16,  
Wis 18, Dex 12, Con 12, Cha 13;  
AL LG; THACO 20.

Spells: *bles*, *cure light wounds* (x3); *goodberry*, *hold person*, *messenger*.

Nicholi is a slim man of average height. Obviously, he could benefit from a few days of hot meals. He is

neighborhood, but Nicholi does best to keep it in good condition.

Services are held every morning at dawn, and twice on Godsdays at dawn and at dusk. Frequently fresh wildflowers appear in front of the pulpit before services.

A narrow stairway at the back of this room leads upstairs. Up here Nicholi stores the donations he has gathered, to be distributed as needed. Six cots line the room, and shelves along the far wall hold blankets and clothing. Three from the corner, against the wall, the shelves stop. Leaning against the wall here are some battered mops, brooms, and buckets.

Behind these cleaning supplies is the entrance to a secret room





live as comfortably as they can. Nicholi has healed almost everyone in Shacktown, has helped deliver babies, and has rescued residents from fires and collapsed buildings. He has an intense survival instinct and knows much about surviving on next to nothing.

If ever a man was loyal to a lost cause, it is Nicholi. He will remain in Shacktown until the day he dies, because he knows these people would die without his help. He has no desire for recognition or rewards, and once turned down an offer to become an assistant at the beautiful shrine in the city. He is also loyal to the City of Greyhawk, for its residents provide him with the donations he needs to keep his flock alive.

Nicholi is warm and friendly, and is a good listener. He is trusting of others and is always ready to lend a hand to anyone in need. Talasek is one of Nicholi's closest friends and best supporters. They trust one another implicitly.

When Talasek brings the PCs to Shacktown for the first time, this is the first place he visits. The time of day will determine where Nicholi can be found. If Nicholi is not at home or at the shrine, he can be found elsewhere in Shacktown in 1d4 turns. Most likely, he is tending to someone who is sick or delivering food or clothing to someone in need.

Very likely, the PCs have never seen poverty such as this. They should feel obligated to make some donation to Nicholi.

### Nicholi's Story

When Nicholi has finished with his task, he leads the way back to his shack. Inviting you to make yourselves comfortable, he stokes the fire and puts a kettle of water on to boil. He is interested in hearing how you became friends with Talasek

and what has been happening. He has no information about the cult, but can confirm the rumor that people have disappeared from Shacktown recently.

"I've lived in Shacktown for many years," he tells you. "I've seen a lot of people come and go. But I know about each and every one of 'em by name. Some of 'em come to me regularly; others never say a word. I can tell which folks are down on their luck and which folks are hiding from something. The ones who are hiding, I leave 'em alone. The ones who are poor—those are sent to me by St. Cuthbert, knowing that I'll do what I can to care for them.

"Most of these people are good folks. They may be poor, but they've got pure hearts. That's why I'm here. They deserve every chance to live a decent life. I intend to do what I can to give them just that."

When the PCs ask about the rumored disappearances, Nicholi sadly tells the PCs that he must confirm it.

"As I mentioned, I know of nearly everyone in this town. And yes, some of them have disappeared lately. Sure, people leave here all the time. But they always take their belongings with them. When you're this poor, every possession is precious. You don't just disappear in the night, leaving everything you own.

"The thing that really bothers me is that none of them said goodbye. Some of them were regulars at the shrine. Others who have left have let me know that they were leaving, and where they'd be going. I was always happy when someone found an opportunity elsewhere or found some family. Usually

I'd try to give them a few things to help them get where they were going.

"But the folks who have left lately—well, they just seem to have disappeared. I worry about them, and I truly hope that they have found a better life somewhere, but I just can't help but think that they're in more trouble than they had here."

Nicholi sighs, and it is apparent that he is deeply concerned. He can show the PCs where the missing persons lived, and he can show them their possessions. When the missing people failed to return after one week, Nicholi packed up their things and moved them to the space above the shrine. If these people did return, he could give them their belongings. If they never came back, he could always distribute the items to the other residents of Shacktown.

Nicholi can provide descriptions of most of the people who disappeared. He knows of seven men and three women who he hasn't seen in over one month. All of them left without their belongings, and none of them were criminals. They were just the ordinary poor. All of them were between the ages of 20 and 40, and in reasonably good health.

Nicholi will answer any questions he can for the PCs. (The DM may adlib freely here. The details and descriptions are not important.) They can also explore Shacktown and examine the possessions Nicholi described.

### The Juggler's Diary

A search of the buildings where the missing persons lived will reveal nothing. A search of the possessions that Nicholi collected will yield the diary of a young man who moved to Shacktown four months ago.

The front page of the diary bears



the man's name—Janson Parlens. The diary tells the story of the past few years of his life. Janson was a juggler in a carnival for three years, but he left because the carnival was sold. The new owners treated the troupe poorly, cut their wages, and generally treated the performers as their own personal slaves. Janson decided that even a life of poverty was better than the indignity of working for those people.

He left the carnival and came to the City of Greyhawk, because the carnival had once visited the city and Janson thought it was a wonderful place. Unable to find work, Janson settled in Shacktown until he could find something better.

The diary ends abruptly, approximately two weeks earlier, which the PCs can correctly guess is due to Janson's disappearance. The entries during Janson's final month yield some clues. The PCs will need to spend some time reading the diary to find the four clues which follow. Nicholi is reluctant at first to let the PCs take the diary, but he realizes that letting them take it may save other residents from whatever fate Janson suffered. He allows the PCs to take the diary if they promise to return it as soon as they have finished with it. For every hour that a PC spends reading, give him one of the clues that follow.

Four weeks prior to his disappearance, Janson writes:

I have never seen the City Watch in this part of the city. Yet last night, well after midnight, I heard a commotion down the street. I tried to ignore it, but whatever was happening was just too loud. I stuck my head out of this shack and saw five members of the City Watch led by a man in black pants, a red shirt, and a black half-cloak. They were accusing some poor man of being a pickpocket in the

City. He denied everything they said, but they certainly weren't interested in what he had to say—they only wanted to make an arrest.

After half an hour of this ruckus, the guards led him away. Their leader knew that people were watching, and announced loudly, "Now let that be a lesson to all of you. We know where to find you. No one here is above the law."

I thought the City Watch ignored this place. I can't believe they made such a spectacle.

If the PCs don't recognize the leader of the City Watch from this description, allow them an Intelligence check to recognize him as Nestor.

Three weeks prior to Janson's disappearance, he writes:

I'm concerned about something I heard last night. I was asleep, but I'd swear that I heard a woman scream. I thought I heard some shuffling noises and a man's voice, but suddenly all was quiet. I thought I was only dreaming, but this morning, I heard that one of the local girls has disappeared. I've seen her around—her name is Mara, and she's about my age. Who would have done such a thing as to kidnap her? No one in Shacktown has any money to pay a ransom. I hope she's all right.

Two weeks before Janson's disappearance, he writes:

It's been one week since Mara disappeared. No one has seen her. I worry about what may have happened. I heard today that another girl disappeared in the night the day after Mara vanished. Her friends went to the Citadel, but the officials

refused to even listen. Funny that they'll come here in the night to find a pickpocket, but they won't investigate a missing person.

One week before Janson's disappearance, he writes:

I saw a strange man wandering through Shacktown today. No one from the city ever comes here—there's really nothing here, no businesses, no shops. This guy seemed to be looking for something—or *someone*. As he passed people, he'd look at them very hard, as if he were trying to recognize someone. He stared at me too, and for a moment, I thought he was going to say something, but he just walked away. He seemed to know his way around here, but I've never seen him before.

No other clues can be found in the diary. Nicholi is unable to offer information based on the diary entries, but he confirms that the people Janson describes are indeed missing. None have returned.

The PCs may return to investigate in Shacktown any time they wish. Nicholi is always glad to offer his assistance. If the DM desires, Nicholi may ask the PCs to help repair the Shrine or other buildings around Shacktown.

When the PCs are ready to leave after their first visit, if they have not already made a donation to Nicholi, Nicholi says to them:

"Is there anything you can spare to help those less fortunate than yourselves?" Nicholi's warm smile and hopeful eyes make him hard to resist. He accepts your donations gratefully and promises to offer prayers in your behalf.



# 5: The Great Burn

Use caution in revealing information from this section to the players. Some of the material is intended for the DM only, to assist him in role-playing and give a better understanding of what is happening in this part of the city. Boxed text, as always, is intended to be read to the players. Some of the text is provided for the DM to hand out to the players in small doses and is indicated as such at those points in the text.

If using the City of Greyhawk boxed set, browse through Chapter 12, GoF, before proceeding with this section of town. There you will find descriptions of the atmosphere for this part of the city, plus several additional encounters.

The DM should also become familiar with the information regarding the Thieves' Guild (GoF, p. 84, and FFF, p. 38.). This section of the city is known as the Thieves' Quarter, and no activities here pass unnoticed by the thieves. At the DM's discretion, the PCs may be pickpocketed at any time, although the thieves rarely attempt to rob those they can identify as mages.

If using a city other than Greyhawk, be prepared with a colorful environment. Consider preparing encounters for the following establishments:

Bakery	Inn
Blacksmith	Jeweler
Brewery	Pawnshop
Fortune Teller	Tavern
Gambling House	Weaponsmith

**DM Notes:** When the PCs come to this section of the city, they are nearly on top of the cult, but do not realize it until later in the adventure. The PCs will be watched closely by cult members eager to learn of their progress.

The cult's "headquarters" lies be-

neath the Great Burn. The amount of rubble on the site makes it impossible to penetrate the cult's lair from the surface. The cult owns several buildings and warehouses around the site which provide access to their underground temple. Cult members who arrive for rituals enter through one of these buildings, then arrive at the temple through underground tunnel connections. Other members arrive by entering the sewers at various points throughout the city, then accessing the temple through the cult's secret passages. This helps to reduce the suspicion that would be aroused by swarms of people suddenly arriving at a single warehouse.

Talasek can lead the way to the burn site, Gruenab can provide directions, or the PCs can obtain directions from almost any resident of the city. When the PCs are within one block of the site, they need only follow their noses. The site is so large that even after all these years, the charred odor still lingers.

You can smell the Great Burn long before it actually comes into view. Residents of this area go about their daily life without even noticing the gaping black void in the middle of their neighborhood.

As you approach the burn site, you realize that as many as a dozen buildings were probably consumed by the blaze. You've heard that the fire was large, but you didn't expect it to be quite *this* large.

It appears that no effort was made to clear away the rubble. Stones, bricks, timbers, and sections of walls and roof lie in an enormous, blackened heap.

Talasek tells you that the mayor of Greyhawk decided that clearing the area would be more dangerous than leaving it lie. A low fence (4') was constructed around the site to prevent children from wandering in accidentally. The fence is certainly no barrier to anyone who wants to enter the site badly enough.

**DM Notes:** The burn site is dangerous because of shifting rubble, sharp objects, and empty pockets beneath the rubble. PCs should make a dexterity check for every turn that they crawl through or otherwise investigate the site. A failed check means that the PC loses his footing in the rubble and suffers damage according to the chart that follows. Simply observing the site from the road does not put the PCs at risk. PCs may fly or levitate over the site to investigate safely, but for every two rounds that a PC maneuvers over the site, 1d4 persons (mostly children) arrive to gawk at the sight.

## 10-sided Results of PC slipping die roll in rubble

- |    |   |
|----|---|
| 1  | Slips but takes no damage               |
| 2  | Falls, tears clothing                   |
| 3  | Suffers 1-3 hp scrapes and cuts         |
| 4  | Suffers 4-8 hp lacerations              |
| 5  | Sprains ankle (10 hp)                   |
| 6  | Sprains arm (10 hp)                     |
| 7  | Suffers concussion (12 hp)              |
| 8  | Breaks arm (1/4 total hp)               |
| 9  | Breaks leg (1/4 total hp)               |
| 10 | Suffers 3d6 + 6 hp; knocked unconscious |

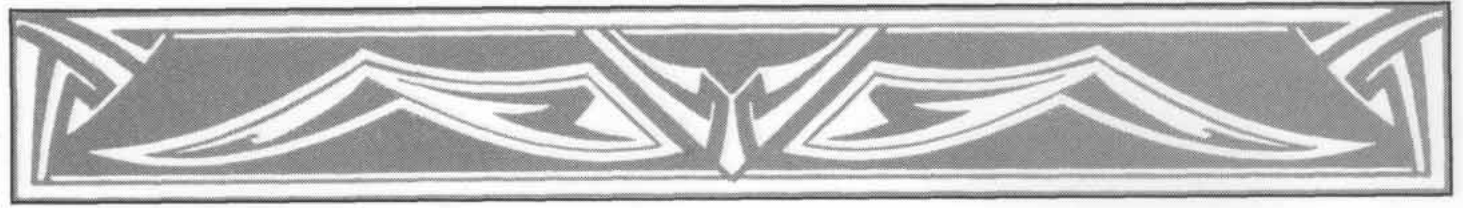

Make certain that the PC informs you of the height at which he is flying over the debris, and informs you if this changes. Should a flying or levitating maneuver fail while a PC is over the site, falling damage is doubled to 2d6 per 10' fallen, due to the sharp debris. (Falling rules appear on p. 72, DMG.) Rescue may put other party members at risk.

For all their trouble and risk, the PCs find no clues at the burn site.

## Local Information

The PCs may also question the residents of this section of the city. Many of the residents are fearful of strangers and the PCs will find more than a few doors slammed in their faces. Others will offer scanty information or nod fearfully when asked about certain rumors. Still others will offer long-winded sermons about the dangers of this site and the ghosts that haunt the rubble.

Allow the PCs to confirm any of the true rumors they may have heard about this part of town. Provide them with any additional rumors about Old City that they may not have yet heard.

As the PCs question the locals, allow them to learn the following information.

- \* The City Watch patrols Old City, but at night they travel in pairs and do not venture off the Processional or the main roads.

- \* Although the Thieves' Guild is powerful, it is not as strong as it has been in past years.

- \* Sometimes people can be seen coming and going from some of the warehouses around the burn site at odd hours of the night.

- \* The Thieves' Guild is aware of every activity in the city, thanks to its strong spy network.

If the PCs foolishly attempt to gain information from the thieves, they are laughed at and told to run

along. The thieves deny having information about the activities in the city. The DM should see that the PCs are pickpocketed and suffer heavy financial losses.

## The Missing Link

One of the local merchants is bold enough to confide in the PCs (he likes the looks of Talasek—a man to be trusted) that a few of the warehouses have some unusual activities. He has seen people coming and going in the middle of the night. Sometimes they are alone, sometimes in groups. Sometimes it appears that travelers are arriving, carrying enough possessions for an extended or permanent stay. He can point out which warehouses have had these occurrences, but will not go near them.

If the PCs approach the warehouses to determine whether they are legitimate businesses, they find busy, bustling enterprises. One is a produce warehouse; the second is a fish processing plant; and the third is a mill and grain storage facility.

All three warehouses are similar. The burly workers ignore the PCs if they attempt to ask questions. The PCs can locate a foreman, who quickly becomes annoyed by too many questions. If asked who owns the warehouse, the foreman's answer is "some rich guy who lives in a big house." He answers most questions with an irritated "I dunno." If asked about his wares, he says, "Look. We don't sell to private parties. Only to da merchants. Now get outta here. I'm busy."

The PCs may decide to stake out one of the warehouses. The DM should decide whether Talasek chooses to accompany them. If the PCs can convince him that they are not breaking the law and that ultimately, the stake-out is for the good of the city, he will accompany

them. In any case, he will insist on telling Nicholi of their plans, in the event that something goes wrong.

If the PCs' plan is sound, allow them to carry it out with relative ease. If the plan is too outlandish or foolhardy, feel free to have the City Watch discover the PCs and drag them back to the Citadel, or create an altercation with some members of the Thieves Guild who happen by at an inopportune moment. The thieves will naturally assume that the PCs are attempting to rob someone or something, and since this cuts into their profits, the thieves will slug it out. The DM determines the outcome of this brawl. If the thieves win, they will force the PCs back to the Guild Hall, where higher authorities will beat them, impose a stiff fine, or other sentence that the DM deems appropriate.

The PCs might win the struggle for many reasons: the thieves could be drunk, the city watch might approach, or they might succeed thanks to their skill alone.

Thieves who are captured know nothing of the cult. They simply inform the PCs that this is thief territory and that the next time they snoop around here, they might not be so lucky.

Before the PCs stake out the warehouse, they should be aware of an important fact. The only exterior gates which remain open during the night are the Cargo Gate and the Highway Gate. The other gates are closed at dusk and opened at dawn.

Of the two interior gates, the Garden Gate is never closed. The Black Gate, which divides Old City from New City, is closed around midnight and is not re-opened until two hours before dawn. After the stake-out, the PCs should check the rosters at the Highway Gate and at the Cargo Gate to determine whether any of the people they may have seen could have come through these gates. Con-



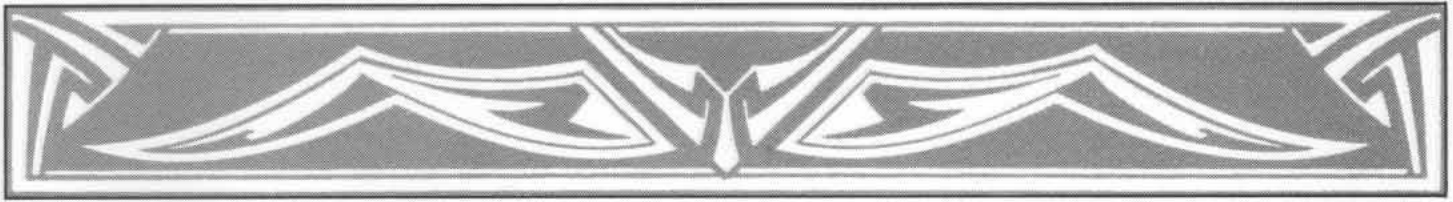

ceivably, a person could leave New City through the Cargo Gate and then enter Old City through the Highway Gate. However, this is not the case, as the PCs will learn.

The PCs may deduce (with an Intelligence check, if necessary) that anyone appearing at the warehouses must already be inside Old City, or knows of a secret entrance.

## Nocturnal Investigations

Ask the PCs for a detailed explanation of their plans before they begin their stakeout. Then make the evening long, chilly, and uncomfortable. If the party tries to find a room near the warehouses to rent for the night, they find nothing available. The only inns that have rooms available are not within view of any of the warehouses. The PCs must rough it outdoors.

**Produce Warehouse:** Beginning about one hour after midnight, people begin trickling toward the warehouses. During the first hour, six people arrive: one pair, and the rest alone. During the second hour, two men arrive together, burdened by great packs on their backs. These men appear to be travelers, judging from the belongings they carry. During the third hour, four people exit the warehouse. The PCs can recognize them as four of the people who arrived during the first hour.

**Fish Processing Warehouse:** Beginning two hours after midnight, three people arrive individually, approximately ten minutes apart. They exit the warehouse together approximately one hour later.

**Grain Warehouse:** One person arrives at this warehouse one hour after midnight. He exits again two hours later.

## The Rosters

From midnight until dawn, the roster at the Garden Gate has three signatures. The first signature is that of a man entering the High Quarter to summon a cleric for his sick mother. The other two signatures are those of the same man and a cleric leaving the High Quarter about 15 minutes later. If the PCs try to verify this story at the Temple, they learn that it is true.

The roster at the Cargo Gate reveals ten signatures between midnight and dawn. All are the signatures of sailors heading for their boat after a night of "entertainment" in the city.

The Highway Gate's roster shows the signatures of two men arriving after a great journey, and the signatures of several farmers delivering their wares for the next day's market. The signatures of the two strangers coincide with the arrival of the two travelers at



the warehouse.

If the PCs stake out the warehouses more than one night, the activity is virtually the same. Different travelers arrive every evening, sometimes alone, sometimes in pairs. The strangers are not just men, but women also.

If the PCs should try to question any of the strangers, they get no answers. These people are rude and evasive, and will claim that they work at the warehouse, are here to begin the early shift, relieve the night watchman, or any other suitable lie. They tell the PCs to mind their own business and not to meddle in the affairs of others.

If the PCs should capture one of the strangers, they still get no answers. The cult members will die before they reveal anything about the cult. If the cult member is wearing his pendant (50% chance), he says that it was handed down in his family. It has nothing to do with any cult or any religion at all. That is a lie, of course.

## The Warehouses

These three warehouses contain secret sewer entrances that are used by the cult to conceal its activities. By spreading the entrances around, they hope to reduce the suspicion that would be generated by large numbers of people coming and going at peculiar hours of the night.

## Fish Processing Warehouse

This large warehouse is easily recognizable due to one unmistakable characteristic: it is like a magnet for feral cats. The odor of fish fills the air, attracting the hungry felines. The workers here don't mind the cats, however, and don't bother chasing them away, because they keep down the mouse population. The cats are sometimes fed the less desirable parts of the many fish that pass through

At the front of the warehouse, large double doors allow wagons to enter the building for loading and unloading. These doors are barred and secured with chain and padlock on the inside at night.

The side of the warehouse has a single door that is locked from the outside at night. This is the door that all workers use to enter and leave the building.

When a wagon to be unloaded enters the building, its contents are dumped into wheelbarrows, then transferred to a large table to be sorted. The sorted fish are pushed into long troughs that slide the fish down to tables where they are sorted, then transferred to another area to be cleaned and gutted. From there, they are sorted to be pickled, salted, or sold fresh.

The entire operation is quite messy and smelly. The floors are always slippery, and a few men are charged with the job of slinging buckets of water over the stone floor to keep the mess to a minimum.

Wide windows fill the long walls of the building at ten-foot intervals. These are necessary for ventilation and are covered with hand-woven screens to keep out insects. The windows are closed at night, except in extremely hot weather.

1. **Loading Office:** This room serves as the business office. All incoming and outgoing shipments are recorded in ledgers stored in this room. Every day transactions are also performed here, typically paying fishermen for their wares and collecting the money for sales made at the market. The receipts are organized by date and are neatly kept, but hold no clues for the PCs.

The office holds a battered desk and two chairs, and many shelves which hold the numerous ledgers. A chest box is kept in a concealed hole in the floor under the desk. The box is locked and usually holds 100 bags.

The hole in which the box is kept is covered by tiles designed to look like part of the floor. A wooden crate filled with papers is placed over this section of the floor at night for additional security.

2. **Foreman's Office:** This office holds all the employer records and payroll information. It is furnished with a desk, three chairs, and many cupboards which hold records. There is no money kept in this room except on Earthday, when the workers are paid.

3. **Stairway:** A wide wooden stairway leads down into the storage cellar. This stairway is generally quite busy with the exchange of filled barrels for empty ones.

4. **Storage Cellar:** Sacks of salt, spices, kegs of vinegar, and both empty and filled barrels are kept down here until needed. Transfer of all product in and out is recorded by a cellar chief, who reports this information to the leading supervisor.

The cellar is approximately the same size as the main warehouse and is about ten feet deep. The walls are built of fieldstone and the floor is packed earth. An elevator platform, operated by hand, is used to move barrels between the cellar and the main warehouse. It requires several strong men to operate the ropes and pulleys. If they put their backs into it they can lift or lower fifty or full barrels at once.

5. **Secret Door:** Hidden behind some barrels is a secret door which leads down a short stairway into the cult's secret sewer tunnels. Only the workers who are cult members, including the foreman, are aware of this entrance. Other cult members sometimes arrive at the warehouse to use this entrance.

## Produce Warehouse

All varieties of fruits and vegetables arrive here from the surrounding farms to be processed as fresh produce, dried, or preserved. Wag-



# Warehouse Maps

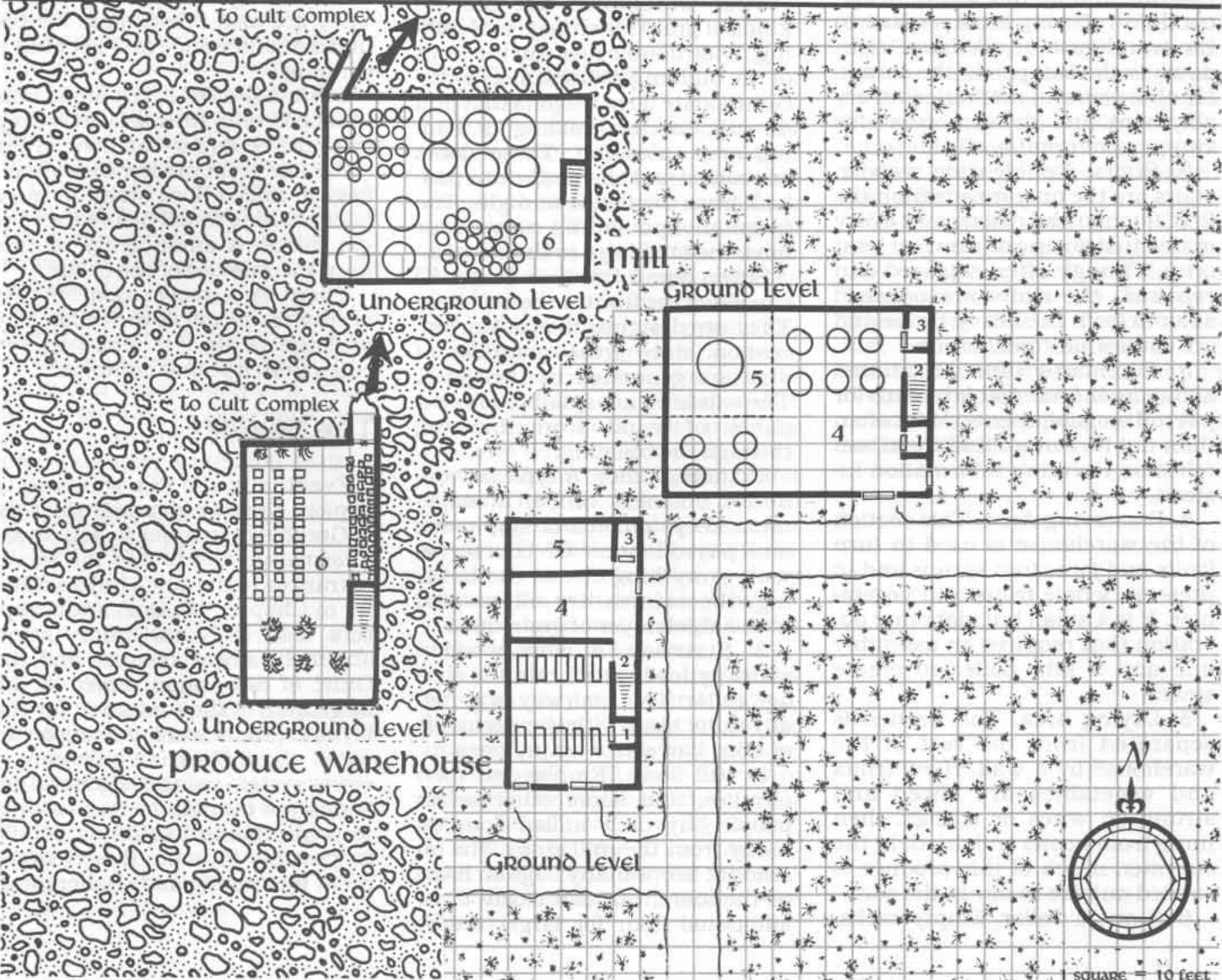
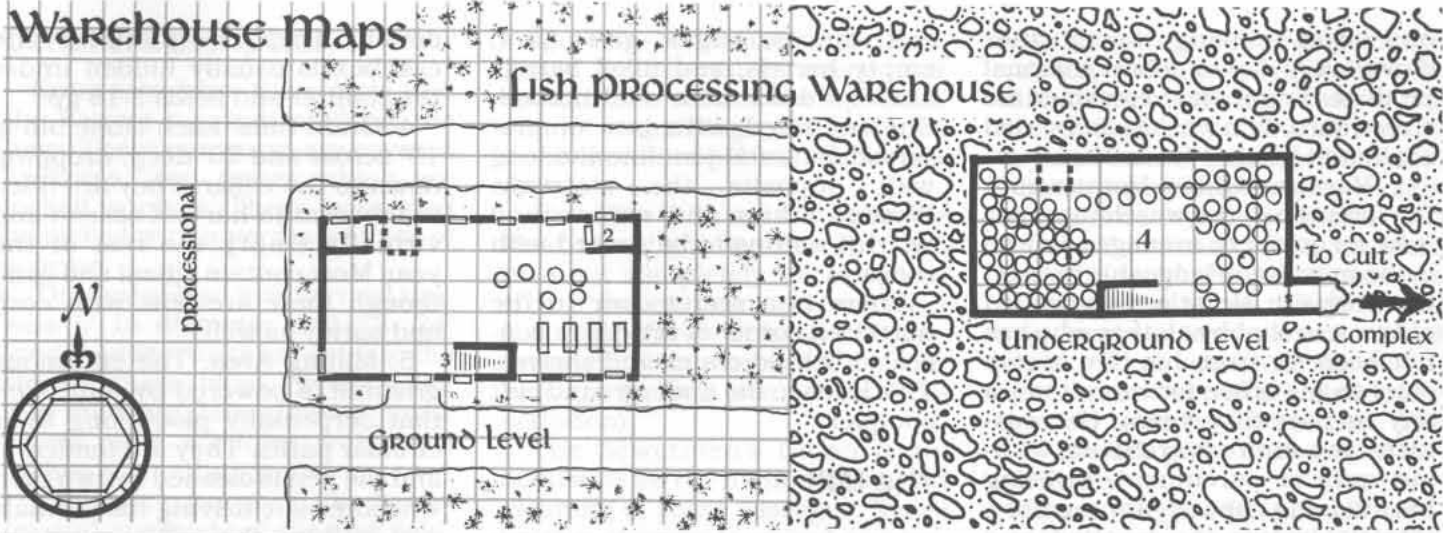



ons begin arriving shortly after dawn every day to deliver seasonal produce. Fruits and vegetables are sorted here, then washed and sorted again into batches for market.

1. Horatio's Office. Horatio isn't the foreman of the warehouse, nor is he an owner or manager. But he is the most knowledgeable man on the work site. Horatio is a wrinkled old man in shabby clothes who has not been far from his tree stump stool in his office for more than a day in over fifty years. He organizes the entire warehouse without quill or parchment, utilizing his amazing capacity for memory. Horatio knows the location and condition of every bit of produce in the warehouse at all times, right down to the last pea in the corner. He observes and memorizes every shipment and delivery from his vantage point in his office.

2. Stairs. Double-wide wooden stairs are the only means from the first floor to the cellar, and every crate must go up and down at least once. Though often replaced and repaired, the stairs are polished smooth from the heavy traffic and are somewhat treacherous.

3. Foreman's Office. Scattered about are the foreman's records for payroll and shipments. More often than not he cannot find them and relies on Horatio's information instead.

4. Preserving Area. This section of the warehouse is used to turn fruits and jams into syrups and to preserve whole fruits and vegetables. It is a small but elaborate operation that requires an assembly line and a kiln boiler to create steam.

5. Drying Area. This section is separated from the rest of the warehouse by a wall. Here, fruits and vegetables are sliced and strung on wires or strings, then hung from hooks and dried. In the summer, much of this produce is carried outside to dry in the sun.

6. Storage Cellar. Empty sacks,

salt, spices, sugar, glass jars, empty barrels, and filled barrels are kept down here until needed. Shelves filled with jars of preserved fruit and jam line the long wall opposite the stairway. Wooden crates and straw stand nearby, waiting to be packed with the jars.

There is a secret door in the northeast corner of the cellar, concealed behind crates and shelves. This leads to the underground cult complex.

## The Mill

This warehouse accepts all kinds of grain for storage and milling. Wide double doors in the front of the building are designed by accommodate farm wagons that pull directly into the building for loading and unloading. These doors are barred and chained with a padlock from the inside at night. The foreman and lading supervisor have the only keys to these locks.

Seven small windows (1' by 1') run along the front of the building. They are designed to provide ventilation, since great quantities of dust are generated by the grain. The windows are small to prevent gusts of wind from blowing through the building.

1. Lading Office. A typical warehouse business office, management keeps records of shipments and payroll here. Of course, as with everything else in the building, the records are all covered with a thick layer of grain dust.

2. Stairway. A wide wooden stairway leads down into the storage cellar. This stairway is generally quite busy with the exchange of filled barrels for empty ones.

3. Mill Store. Employees, their families, and some other select people buy their milled flour directly from the mill store. The attendant keeps many bags on hand in the store, but can easily draw additional flour for larger orders

directly from the gristmill. The cashbox is usually hidden under the counter and holds 3-18 gp.

4. Grain Bins. Each stone bin is 10' across and 20' deep, dropping down to the cellar. They are filled to the brim in harvest season and virtually empty the rest of the year. Most contain wheat and oats, though there are bins with corn and barley as well.

5. Milling Area. The enormous gristmill is powered by four oxen that perpetually plod along their circular paths. They are tended to and the pen is cleaned by two men who alternate driving the animals and watching the mill's operation. They are also responsible for the mill's maintenance and keeping it running.

6. Storage Cellar. The stone bins that open onto the main level drop from the ceiling to the floor in the cellar like great pillars. Elsewhere, bags of milled flour stand in huge piles, waiting to sell before they begin to rot. A small army of cats keep the rats out of the cellar.

There is a secret door in the northwest corner of the cellar. The passage behind it leads to the cult's underground complex.

## The Sewers

Eventually, the PCs will need to explore the sewers under the City of Greyhawk in order to gain more information and to find the secret entrances to the cult's hideout. Refer to Chapter 13, GoF, and Chapters 4-5, FFF, for information about the sewer systems and the Guild of Sewermen. Refer to the large map of the undercity for the layout of the sewers. If using a city other than Greyhawk, create a sewer system using the general descriptions that follow and tailor it to your city. Add as many details as possible to make this environment interesting and challenging.



## General Description

Entrances from the streets into the sewers are indicated on the map. These entrances are covered by large, iron grates which are locked in place. These locks may be picked with a normal chance of success.

The grates lead into vertical tunnels 6' in diameter and 12- 24' long. Ladder rungs are set into the side of these pipes, which open into the main, lateral sewer pipes. These pipes are filled with 1d12 inches of standing water.

The main pipes are 10' in diameter and are made of tile and fieldstone. The pipes are cracked in many places and cave-ins have occurred. In this adventure, the PCs have no need to explore the caved-in areas. The DM should use his discretion if the PCs insist on exploring a caved-in section.

The random encounter table from GoF is reprinted here for the DM's convenience. Use this any time the PCs venture into the sewers.

The DM should roll 1d6 every turn. On a roll of 6, the PCs have one of the following encounters. If the encounter takes place in a watery area, roll 1d4 to determine what creatures are met; if the area is not one of standing water, roll 1d12.

## Undercity Random Encounter Table

Die Roll	Encounter
1	1d4 Giant Crayfish
2	1 Giant Crocodile
3	3d6 Giant Rats
4	1 Giant Snake, Constrictor
5	2d12 Giant Centipedes
6	2d6 Large Spiders
7	100 Bats
8	1d6 + 1 Carrion Crawlers
9	1d4 Poisonous Snakes
10	1 Neo-otyugh
11	1d4 Black Puddings
12	1d4 Otyughs

The PCs face another major danger in the sewers; for every hour spent in the sewers, there is a 2% chance of catching a disease (up to a maximum of a 15% chance per day).

The PCs will need to provide their own light source. The tunnels are completely dark, except where the entrance grates pierce the world above. This light is poor, however, since the entrance tunnels are so long (see previous description).

The Sewermen's Union is responsible for the maintenance and cleaning of these passages. Every section of sewer is visited an average of once per week.

## Sewer Zombies

Due to the hazards of sewer maintenance (disease, monsters, etc.), the Union has created a plan to ease their work and make their jobs easier. The simple solution: use zombies to do the work. Roughly 25% of the workers in the sewers are zombies raised with the help of a well-paid evil priest. The sewerworkers are careful to maintain this secret, since discovery of the zombies by city officials would mean more work, less pay (the zombies don't collect their salary, so the Union does), and greater risks. The PCs have no way of knowing that zombies roam the sewers. The DM should use his discretion in determining any encounters with zombies (whether the PCs have had enough battles or have been badly beaten).

When the PCs encounter sewer workers, they are at first told politely that they do not belong in the underground. If the PCs persist, workers will call their foreman, who tells the PCs that if they do not leave, he will call the City Guard. PCs would be wise to leave and return later, because the foreman will not hesitate in calling the Guard.

Although the sewerworkers are not dependent on daylight (the tunnels are dark regardless of the time of day), they still work mainly daytime hours. During the heat of summer and following an exceptionally heavy rain, crews and shifts are increased. PCs are more likely to encounter sewer workers during these times. Very few, if any, workers are encountered at night. The zombies, however, work around the clock, since they have no need for food or rest. The DM should plan encounters accordingly.

Regardless of where the PCs enter the sewers, they should realize that they must head for the site of the Great Burn. The DM has the option of making this journey easy or difficult. The number of possible encounters is nearly inexhaustable. And there is always the chance that the PCs will become completely lost.

Guide (or mislead) the PCs in any way you choose. Use the information given here and in the boxed set, or make up your own adventures. Secret doors, cave-ins, and mazes abound in the sewers. This part of the adventure is up to the DM until the PCs discover the secret passages that lead to the cult's lair.



## 6: The Diary

Once the party has adventured through the sewers and discovered the cult's lair, Talasek decides that it is time to tell the story to the clerics at the Temple. Perhaps they can offer assistance or information in order to stop the cult.

Talasek requests that the PCs accompany him. They will need every scrap of information they can remember in order to build a plan against this menace.

Talasek will arrange a meeting between himself, the PCs, and the high clerics. When the PCs arrive at the temple for the meeting, read to them the following.

You arrive at the Temple and approach the building where Talasek stayed after his attack. A cleric waits for you in the foyer. He does not ask your names, but recognizes you, smiles, and says, "Please follow me."

You are led to a large meeting room which holds a long, oval table. Talasek is here, but the clerics have not yet arrived. The cleric who led you here says, "I will let the others know that you are here. They will be along momentarily."

The furnishings and draperies of this room are simple but of excellent quality. Two ornate holy symbols hang on the walls at opposite ends of the room. The most striking features here, however, are the twelve life-size paintings which fill the long walls of the room. Each portrait hangs in its own intricately carved frame.

Of the twelve portraits, five can be recognized as paladins and seven as clerics. The men are attired in their best costumes: the paladins in plate ar-

mor, bearing sword and shield, and the clerics in fine robes.

Talasek notices you observing the paintings, and begins to explain. "These are men who devoted their lives to St. Cuthbert and performed noble deeds in his name. The priests you see are the former heads of this temple. The paladins, each in their own way, performed some outstanding service that required bravery and selflessness in the superlative.

"The man you see here"—Talasek approaches one of the paintings—"is my grandfather, Talamar Thraydin. I never knew him, but the legends say that he fought and defeated an evil cult in the city. It somehow seems appropriate that we are here today to discuss a similar evil.

"These were humble men—many of them objected to being honored in this way. But the priests insisted, so that all who followed in their footsteps could learn from their examples. Many of the apprentices—in fact, all the priests here—come to this room in times of need and to extract inspiration. The clerics who started this tradition were wise indeed. I wonder if they know how many men and women have been helped along the way by the inspiration this room provides. This is why meetings are held and decisions are made in this room—in the hopes that these men will guide us in the direction of truth, as St. Cuthbert would desire.

The painting of Talamar Thraydin portrays a tall man wearing beautiful plate armor. You can see the resemblance to Talasek in his strong features

and green eyes. He cradles a small, green book in one arm, and his other hand rests on the hilt of his sword which stands on end, the tip pointing into the ground. His shield stands propped up next to his feet. A gold holy symbol of St. Cuthbert hangs from a woven silver and gold chain around his neck.

### Right Under Their Noses

You notice that all the other paladins hold their sword in one hand and shield in the other, in various poses. You ask Talasek about the importance of the book that he holds so carefully. Talasek thinks for a moment, then says, "You know, I've seen this portrait so many times that I don't even notice the book any more. I wonder if it could be the same book my father used to read. I was very young when my father died, so I'm sure it was something I wouldn't have understood. But I do remember seeing my father reading a book that looked just like that one. I must ask Eritai when she arrives whether the book still exists. You're right—it couldn't have been a trifle if Grandfather wanted it in his painting."

### The Meeting

The door opens at that moment and four clerics enter the room: two men, followed by a woman, followed by a scribe.



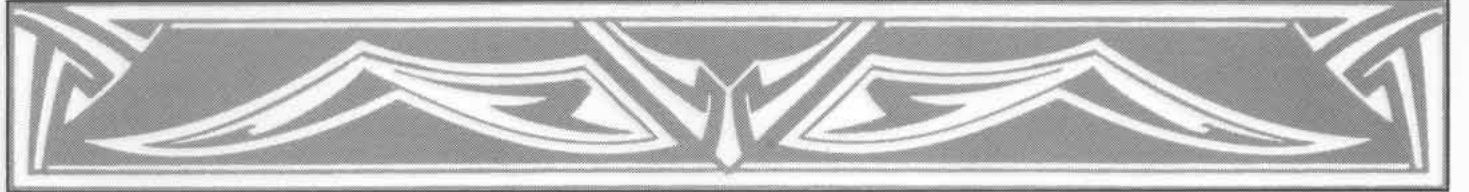

The scribe wears the reddish-brown robes you have seen the other clerics wear, but the woman and two men are garbed in green. They greet Talasek warmly, then Talasek introduces you to Eritai Kaan-Ipzirel, head of the Temple, and her assistants, Latmin Doru and Figril Himman. They all seem genuinely pleased to meet you.

Once the formalities have been accomplished, Talasek turns to Eritai to ask her about the book. "Forgive me, but before we begin the meeting, may I ask you about the painting of my grandfather?" Eritai nods. "I was wondering," Talasek begins, "if you know anything about the book my grandfather holds in the painting. I seem to remember that my father had a similar book when I was a child. Do you know if this is the same book, or where it might be found? I suppose it has been lost after all these years."

Eritai whispers something to the scribe, then turns to Talasek. "That book was a record of all the important deeds of your grandfather's life. He recorded events himself in order to pass the family history from generation to generation. When your father died, your mother brought it here to be stored in the vault along with your armor and weapon. She feared that upon her death, there would be no one to pass along your family property. She told you about the armor, but must have neglected to tell you about the diary. I've sent the scribe to notify the Vaultmaster to locate it. If you've never received it, it must still be in the vault. We'll know in a few moments. In the meantime, let us take our places."

Eritai walks to the far end of the great oval table and takes

her seat. The other men take seats to the left and right of her. Talasek sits next to Latmin and motions for you to take seats nearby. Talasek is visibly excited to have learned about the book and that it may still exist.

Just as you are getting settled, the scribe reappears in the doorway. He walks up to Eritai, stands behind her slightly, and says that the Vaultmaster is searching for the book at this very moment. He will send a message with the results of his search. He then pulls a high stool and a tall, narrow writing table from against the wall over to a position behind Eritai's left elbow. From his perch, he can see and hear everyone at the table and he begins to write.

Eritai begins the meeting with some formal notations for the record regarding the purpose of the meeting. She then asks Talasek to tell his story. Between Talasek and the PCs, all the details of the investigation are revealed. Talasek does not omit even the smallest detail.

Eritai, Latmin, and Figril listen intently and interject a few polite and interested questions. They begin to look concerned as the story nears its conclusion. Even the scribe looks up from his furious note-taking with a worried look.

When the story has been completely told, Talasek asks the clerics for their advice and assistance.

Eritai is the first to speak. She admits her concern and informs everyone at the table that this is a matter best kept quiet for two reasons. The first reason to keep the problem quiet is to avoid panic. She does not want word of this spreading through town. The people here are, after all, very superstitious. To allow this information to slip out could undo much that the Temple has already done.

Eritai's second reason for keep-

ing the story quiet is to prevent the cult from learning of the Temple's knowledge of their existence. She feels that whatever the cult is doing could be accelerated if they become afraid of interference from the Temple. She tells Talasek and the PCs that they must learn what they can and plan their strategy carefully so they can put a stop to the cult. If the cult becomes suspicious, it may act before the PCs can organize their plans.

Eritai asks her assistants about the whereabouts of two other paladins, but the answers are that the paladins are on missions far from Greyhawk. Eritai thinks for a moment, then addresses the party.

"I wish I had an answer for you, but I am at a loss. Our resources are poor at this time. I regret that I have no one to offer you assistance. But the group I see assembled here before me looks like a formidable one. You have obviously weathered many battles and challenges. You have already come a long way toward fighting this evil. I do not know that my best people could do more than what you can do yourselves.

"Talasek is well-respected and a favored son of the Temple. If he has chosen you, I believe he has chosen wisely. I would ask that you continue your investigations and make recommendations to the Temple for eliminating this evil. I will continue to give thought to the matter and consult with my assistants. If we can assist, we will certainly do so. But right now, I must admit, I have no one available to join this cause. And those who stand ready are not as strong as yourselves."

Eritai's assistants speak a few words of agreement. They conclude the meeting apologetically, but all look concerned. Eritai then

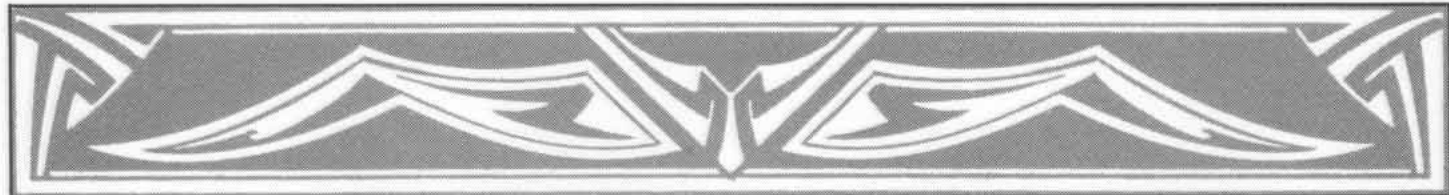

tells Talasek that he may visit the vault to learn whether his book has been located. She has informed the Vaultmaster to give to Talasek when it is located.

## The Family Heirloom

The PCs may opt to accompany Talasek to the vault or do more investigating. If they go to the vault, Talasek leads them downstairs to a small room equipped with a desk and chair and several stools. The walls of the room are lined with shelves of ledgers. Talasek rings a small bell, and in a few moments, a cleric appears.

The cleric recognizes Talasek immediately and informs him that he was just about to send a messenger to find him. He has located the book. He hands Talasek a small, worn leatherbound volume. After Talasek has signed the ledger on the desk, he begins looking

through it excitedly.

The green book is indeed an account of his grandfather's adventures. Talasek easily gets lost in the pages.

Talasek will tell the PCs that if the legends about his grandfather are true, there may be clues in the book. They might learn from his grandfather's experiences.

Talasek will need several hours to look through the book to find the account of his grandfather's battle with the cult. The handwriting is cramped and the ink is faded, requiring careful, slow reading. Talasek is eager to begin, but will wait to go back to his room to begin reading. He will locate the PCs when he has found anything important.

Four hours later, regardless of the time of day or night, Talasek seeks out the PCs, unless they are in the sewers or somewhere that they can't be found. He tells them that he has found the clues they need and that the situation is be-

ginning to make sense. They can now begin planning a way to dispel the cult from Greyhawk once and for all.

## Talamar's Saga

The account of Talamar's battle with the cult reads as follows:

We have finally put an end to the menace that threatens Greyhawk. Gods willing, we will never be forced to fight such a battle again. We all feel fortunate that we learned of the cult in time, before it became too powerful.

The cult was discovered by the priest who operates the shrine in Old City. He received complaints from his parishners that their teenage children were being recruited into a "club." At first, the parents were





not worried much, but as the behavior and attitudes of their children began to change for the worse, their concern grew. They asked their priest, Nymman Sent, to speak to the club leaders and learn what was happening.

Nymman arranged a meeting with the "club." Afterward, he told some of the parents that the club had no intention of slowing or stopping their activities. Nymman informed the club that this would not be the last time they would hear from him.

The evening following his meeting with the club, Nymman's room was broken into and he was severely beaten. His attackers told him not to meddle in the business of others, and that a club in Greyhawk was not his concern. Some of his parishoners found him and took him to the main Temple in New City for aid.

Nymman told his story to the clerics there, and they decided to investigate the club. Nymman felt that this was no ordinary club; there was something deeper and darker involved. He was right.

At this point, the Temple clerics decided to assemble a party to investigate and, if necessary, put an end to the club.

The clerics who investigated began at the place where Nymman had his meeting. When no one could be found, they examined the room and found a secret passage. The passage led to an underground chamber. A small room was found filled with cloaks, hoods, black candles, and foul-smelling incense and herbs. They knew that this evil was great.

On the other side of this room, a doorway led to an enormous chamber. This was not a natural chamber; it had been hollowed out of the earth recently. But

what terrified the clerics most was the enormous unholy symbol of Iuz that stood in the front of the chamber. It was surrounded by black candelabra bearing black candles, draped in filmy, black fabric. An altar also stood in the front of the chamber, which appeared to be carved from the rock that made up the floor of the room. It appeared that as the room had been excavated, a great block of stone had been left behind, which was in the process of being carved into an altar. This was the greatest reassurance; the altar was unfinished. Perhaps their powers were still weak.

The investigators hid in the chamber in order to learn more. Eventually, a woman entered the chamber, examined the altar closely, and made some notes on a parchment. Then she checked the candles and the unholy symbol, looking pleased. As she prepared to leave, the clerics approached her to speak with her. She became angry immediately and told them to leave. Before the clerics could even move, a lightning bolt issued from her fingertips, wounding the clerics severely. She transformed into a falcon and flew from the room. The clerics escaped with their lives.

The second time, more powerful clerics were sent to investigate. They entered the large chamber and observed the falcon-woman with three men. Together, the clerics examined the altar, the unholy symbol, and the candles, talked among themselves, and finally knelt before the unholy symbol of Iuz and began to chant. This went on for several minutes before they were finished. The clerics launched an attack, but the woman again turned into a falcon and escaped. The clerics

battled her assistants, but were forced to retreat when they were badly wounded.

The Temple clerics decided that stronger measures were needed and selected myself and Elliman Neshir, another of the Temple clerics, to lead an attack on the cult. Elliman and I had been acquainted for many years. We were told to select two other men to accompany us; men of our own choice, but who could be trusted implicitly.

We did not need to debate long to decide who our fellows would be. We chose Quevell Maxem and Mizaab Zalen, both mages. They readily agreed to assist us.

Meanwhile, Nymman, the cleric in the Old City, was appealing to the young men and women who were known to be cult members. Many of them would not discuss the cult, but two young women expressed their desires to cease their involvements. They had been told, however, that once in the cult, they were not allowed to leave, and they would suffer if they tried to quit.

Nymman learned from the young women that the falcon-woman and her three assistants were the only leaders of the cult. We were horrified to learn that nearly every member of the cult was under the age of twenty years. There were approximately seventy followers. The women guessed that no one had acquired any powers due to the infancy of the cult. They also provided the date and time of the cult's next ceremony.

We decided to spare the followers due to their youth, and focus on the woman and her cohorts.

The mages debated long and hard about the falcon-woman's powers. They could come to no conclusions about whether her



powers were the results of a spell, a magical item, or even natural ability. Their final decision was that Greyhawk would be safer if the woman were trapped in an eternal prison with no means of escape than if we killed her. By killing her, there was a risk of her reforming or resurrecting, depending upon where her powers were derived. We built a plan with the goal of destroying her assistants and imprisoning the falcon-woman. The mages went to work to plan their spell casting. I retired to rest and pray.

Four days later, after intense research and discussion, Quevell and Mizaab were ready. They explained that the Falcon, as we had come to call her, would be trapped in her own dimension, completely cut off from the outside and absolutely alone. Using both their powers, they could make certain that the prison would hold for all eternity. Although I understand little of arcane power, I trusted them to be correct.

We arrived at the chamber near the time that the ceremony was supposed to begin. We slipped inside invisibly and waited for the moment to strike.

When everyone was assembled in the main chamber, a bird flew into the room and landed at the front. We could see that it was a falcon, but within moments, the bird transformed into the woman who had been described to us earlier.

After a few moments, we put our plan to work. The mages prepared to cast their spells, and I began to creep toward the front of the chamber. I waited for them to begin, and stood ready to fight her assistants.

Suddenly, a shimmering globe appeared around the woman. She opened her mouth to scream, but no sound was heard. A cloud began to form at her feet, growing ever larger. Her assistants moved toward her to help, but I rushed at them to prevent their interference. Some of her followers screamed, others threw themselves to the floor for protection.

The cloud at the Falcon's feet had risen up to her waist, and now lightning crackled inside the cloud. The woman writhed in anger and in pain, then began to transform again. A hole began to open in the cloud, beneath her feet, and she began to sink. I could see that the magic of my friends was working, but I had not anticipated the sight that now stood before me. The woman's body had transformed into an enormous snake, but her head remained. The snake body writhed and wriggled, but could not break free of the spells that now held it.

As I battled her assistants, I could see her form continue to sink into the cloud. My battle was easy, for her men were not trained to fight, and wore little protection.

Finally, the snake-woman sank completely from view and the cloud closed the hole above her head. The last swirls of mist seemed to sink into the floor after her, then it was over. The snake-thing was trapped. Her assistants were dead. Elliman had managed to control her followers, who now stood in shock. Elliman spoke eloquently and informed her followers that they were no longer the victims of this woman's evil. They would

do best to forget what had happened, if that was possible, and to go on with their lives.

We collected the robes, hoods, and candles, the bodies of the dead cultists, and all other objects of evil, and made a heap in the center of the floor. Some of the followers assisted us, obviously relieved to be free of this evil. Others left quietly.

We set fire to the evil pile and watched it burn, then began evacuating the cult members. This was not difficult, because the foul odors were more than any of us could tolerate.

When all had been evacuated, we returned to the chamber to see that the fire had died to a smoldering pile of glowing embers. Satisfied that we had conquered this small part of Iuz's evil, we returned to the main temple.

As we discussed the events of the battle, I learned that the mages were as surprised by the woman's snake transformation as I was. They admitted that they had not expected this, but they felt certain that their magic would still hold her. This led them to believe, however, that her ability to change shape was a natural ability and not the result of spells or magical items.

I cannot help feeling uneasy, however. Although I trust my colleagues completely, I do not understand enough of the arcane arts to feel certain that the snake-falcon-woman is trapped for all eternity. I have recorded this account of our battle in order to advise those who may face her again. If she escapes, she will surely return to seek revenge on this city and those who trapped her.



# 7: Where Evil Lurks

Read Chapter 8: The Spurned Cult of Iuz carefully before proceeding with the PC's exploration of the lair.

When the PCs discover the cult's lair is completely up to the DM. If the PCs do not have enough information about the cult, the discovery may be delayed. If the PCs figure the cult out quickly, they may find the lair sooner. The DM should "allow" the PCs to find the secret entrances to the lair whenever he feels the party is ready.

The cult lair can be entered only through the secret sewer tunnels or the tunnels under the warehouses.

A distinction is made in the following sections between "members" and "priests." A "member" is a worshiper of Iuz who belongs to the cult but is not a priest. Members arrive for meetings and ceremonies, but do not live in the underground complex.

"Priests" and "acolytes" are full-time followers who live in the complex. The term "acolyte" is used to refer to 1st through 3rd level clerics of Iuz. The term "priest" refers to 4th through 6th level clerics. In AD&D® 2nd Edition terms, they are all priests—the distinction made here is for the sake of clarity.

Finally, there is one elite group of clerics, the cult leaders, who enjoy additional privileges and direct the cult's activities. There are only three cult leaders. Many areas of the complex are restricted to all but the leaders and are unknown to the priests and acolytes.

Most area descriptions indicate which persons know of their existence. For the DM's convenience, the following table summarizes the areas and the followers who may access them.

Follower class	Areas of access
M,A,P,L	1-9
A,P,L	10-15
A,P (see note),L	16
L	17-21

M = Member, A = Acolyte,  
P = Priest, L = Leader

Note: Acolytes and Priests are aware of the door leading to area 16, but are not allowed beyond the doorway. They know that these are the private quarters of the cult leaders, but have never been allowed into this area. The map is on page 37.

## Encounters in the Cult Complex

The usual residents of each room within the lair may or may not be there when the PCs arrive. Use the notes following each room description to determine the locations of these residents when the PCs enter. Obviously, even chambers noted as being occupied at night will be vacant during ceremonies.

## Locations Inside the Lair

**1. Sewer Entrances:** These are the secret passages which lead from the city sewers to the lair. The sewer men are not aware of these tunnels, but nearly every cult member knows their locations. All members know of at least two entrances to the lair, in case one of the routes is blocked or inaccessible.

The tunnels have a hard-packed dirt floor, and the walls and ceiling are supported by wooden beams. Near the lair, the tunnel walls and ceilings are lined with rock and the

floors are covered by slabs of stone. The construction crew of the lair has begun the finishing work on the tunnels, but it has not yet been completed.

Near the city sewers, the floors of these tunnels tend to be wet with the water that seeps in when the secret doors are opened. Wet footprints can also be seen on the dirt floor for 1-2 hours after someone has passed through a secret door.

The secret tunnels are inhabited by a disgusting swarm of small monsters called grythoks. They are capable of recognizing creatures of good alignment and immediately drop to attack them. When one grythok becomes aware of a good creature, it emits a high-pitched shriek that is inaudible to humanoid ears. Other grythoks begin to swarm toward the area, arriving at a rate of 1d8 per round.

**Grythoks (80):** AC 5; MV 1, Fl 8; HD 1; hp 4; #AT 1; Dmg 1-6; SA disease; SD none; AL Nil; THACO 19.

Perhaps eight grythoks have escaped the private sewer tunnels of the cult and entered the public sewers. However, the chance of encountering grythoks there is slim (1%) since the public sewers are so expansive.

## Chance of Encountering Cult Members

	Leader	Priest	Acolyte	Member
Morning:	2% (1)	5% (1)	5% (1-3)	5% (1-2)
Afternoon:	2% (1)	8% (1)	10% (1-3)	5% (1-3)
Evening:	0%	0%	8% (1-2)	5% (1-2)
Night:	0%	0%	0%	10% (1-3)

The numbers in parentheses show the number of cult members encountered.



**1A. Bone Pit:** This 40' long pit is filled with bones and skulls. The depth of the pit is concealed beneath the mass of bones, and will have to be probed. Ten feet into the pit from both ends, the pit is 1' deep. In the center 20'-long section, the floor of the pit is uneven and drops to a depth of 3' at unpredictable locations.

Many of the bones are still connected as hands, feet, and ribcages. None are complete skeletons.

When anyone approaches the pit, the bones animate and attack. However, they are not complete bodies and attack as individual hands, feet, and skulls. They are not able to move and cannot creep out of the pit to attack those approaching it.

The cult leaders decided that a trap was needed in one of the tunnels, and placed this pit away from the cult's quarters. Although ineffective as individual units, the bone sections are formidable in large quantities such as this.

The dismembered limbs and skulls chatter and grab at anyone who enters the pit. The skulls attempt to bite anything that moves; hands grab and claw, and can climb up loose garments such as robes.

**Skeletal Remnants (200):** AC 8; MV 6; HD 1-1; hp 2; #AT 1; Dmg 1-2; AL N; THACO 20.

If a character decides to enter the pit and attempt to wade across, his movement is slowed to 25%. The character is subject to 5-8 attacks per round per foot of depth. In the outer 10' lengths of the pit, roll normally for attacks. In the center 20' section of uneven depth, the character must make a dexterity check at -4 to avoid slipping into a deeper section.

Example: Waldorf, whose movement rate is 12", enters the pit. He

now travels 3" per round. During the first three rounds, the pit is 1' deep. He suffers 5-8 (1d4+4) attacks per round.

During the fourth round that Waldorf is in the pit, he enters its uneven middle section. In order to proceed, he must pass a dexterity check at a -4 penalty. Failure means that he has slipped into a deeper section.

Roll 1d3 to determine Waldorf's current depth. Waldorf must now pass a second dexterity check at -4 penalty to stay on his feet. Failure means he has fallen and suffers 5-8 attacks per foot of his height. Success means he maintains his footing and suffers 5-8 attacks per foot of depth. He must pass another dexterity check at -50% to regain his footing. He must continue to make dexterity checks once he has regained his footing in order to continue through the pit.

If a character is tied to a rope before he enters the pit, there is a 1% cumulative chance per two rounds that the rope is bitten in two by a skull. If the rope is held out of the bones at all times, the rope is not subject to attack. Any time it touches the bones, it has a chance of being severed.

If a character attempts to fly over the pit and falls in, he suffers 2d6 damage when he lands in the pit. Roll 1d3 to determine the depth at the point where the character fell. He continues to take damage as described previously as long as it takes him to wade out of the pit.

If the PCs attempt to remove any of the skeletal sections or skulls from this area, the pieces gradually weaken and cease to move. Beyond 100' of the pit, the pieces do not move at all. If returned to the pit, the bones will reanimate after 2-6 days.

**2. Killer Foyer:** A secret door leads to this 30' by 30' room. Inside, four piles of skeletal remains lie on the stone floor. Examination

reveals them to be the skeletons of giant cats. The cats are unusual, however, in that they each have two enormous fangs where their canine teeth should be. PCs may correctly guess that when these cats were alive, these teeth protruded from their mouths at least six inches.

The other feature of this room is a large symbol of Iuz on the east wall. The symbol is made of mosaic set directly into the stone wall and radiates a strong aura of magic.

**Skeletal Sabre-tooth Cats (4):** AC 6; MV 12; HD 6; hp 40, 36, 32, 28; #AT 3; Dmg 1-3/1-3/2-12; AL N; THACO 15.

The skeletal cats animate when anyone enters the room, but they attack only creatures of good alignments. When one of the cats is slain, it falls to the ground for three rounds, then rises and attacks on the fourth round. The skeletons are reanimated by the powers of the unholy symbol of Iuz that is built into the wall. They continue to reanimate until the symbol is deactivated or destroyed or no more good creatures remain in the room. When all good creatures are dead or have exited, the skeletons remain animated for six turns, then fall to the floor in heaps to await their next victims.

The symbol may be deactivated for one turn by means of a *dispel magic* against 12th level ability. The skeletons immediately fall to the floor if the spell is successful. After one turn has elapsed, the unholy symbol regains its power and the skeletal cats attack normally.

If the skeletons are removed from the complex, their magic no longer functions. If they are killed outside the room with the symbol, they will not reform, but if moved back into the influence of the symbol, they will reform normally.



# Underground Cult Complex

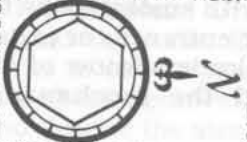
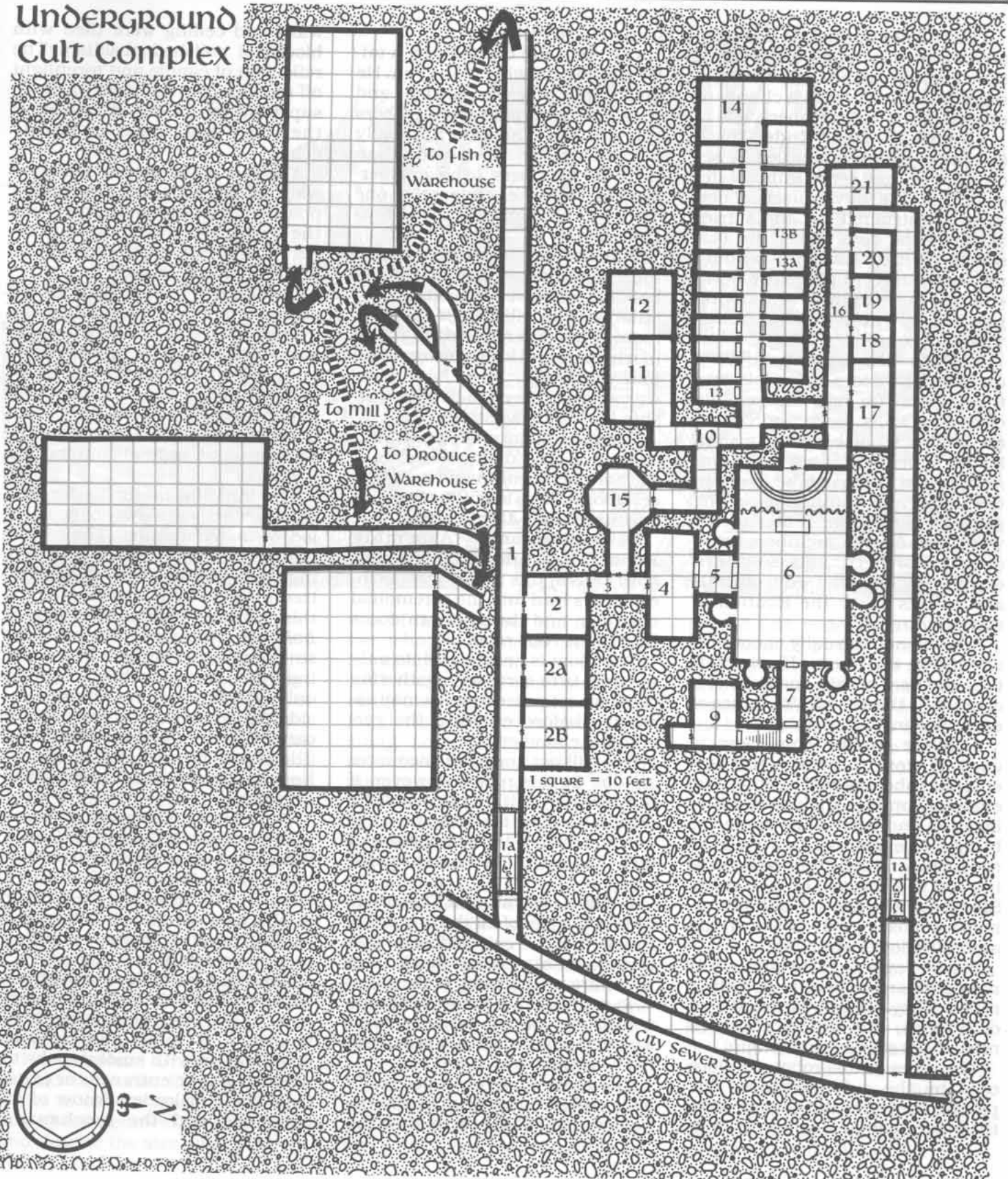

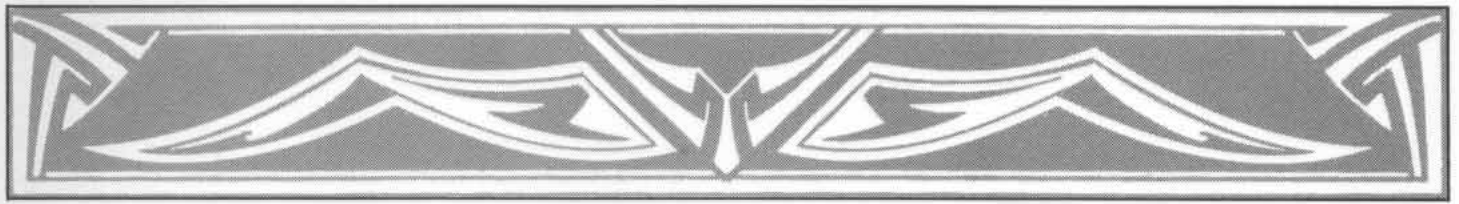

PCs will not normally encounter anyone in this room. However, if they are here within one hour of a ceremony, there is a 25% chance of encountering 1-6 members.

**2A and 2B. Dead Ends:** These are empty rooms concealed by secret doors that serve only as decoys and are never used. They were constructed for the future needs of the cult. When the PCs search here, they will find nothing unusual, but might stay long enough to encounter wandering grythoks. These rooms are always unoccupied.

**3. Hall:** This appears to be a dead-end. No doors are visible, and the area has no light source of its own. The walls, floor, and ceiling are built of stone blocks in a similar but superior manner to the tunnels. Secret doors can be found in the north and south ends of the passage and in the center of the west wall. All cult members know of the northern and southern doors, but only the cult officials and priests know the location of the western door.

PCs will not normally encounter anyone in this room. However, if they are here within one hour of a ceremony, there is a 35% chance of encountering 1-6 members.

**4. Robe Room:** This room is used to store the cult's 100 ceremonial robes, as well as other ceremonial supplies such as candles, incense, and herbs. The robes are hung on pegs on all four walls of the room, and are grouped according to the length of the robe. Shelves above the robes hold numerous boxes and crates of the aforementioned supplies.

Before every gathering, cult members arrive here to don their robes. They are not assigned specific robes, but simply choose a robe of the appropriate length.

The robes in this room are worn only by the cult members. The priests, acolytes, and leaders store their own personal robes in their

living quarters.

The robes are cared for by a tailor who is a member of the cult. He mends the robes as needed, and sews new ones as more members join the cult. The tailor normally has a few more robes ready than there are members, to cover emergencies. He makes certain that one extra robe of each length is always at the ready.

To maintain the sober nature of these ceremonies, the cult members have been cautioned against talking or socializing in the robe room. They are required to speak in whispers and keep conversation to a minimum. They have been warned that they are here to worship *luz*, not to socialize.

PCs will not normally encounter anyone in this room. However, if they are here within one hour of a ceremony, there is a 50% chance of encountering 1-12 members.

**5. Ceremony Assembly Room:** There are double doors at both ends of this room. The northern doors lead into the ceremonial chamber, and the southern doors lead to the robe room.

The room is empty, and its only purpose is to serve as a gathering room where processions may assemble before entering the ceremonial chamber.

PCs will not normally encounter anyone in this room. However, if they are here within one hour of a ceremony, there is a 50% chance of encountering 2-16 members and a 25% chance of encountering 1-4 acolytes.

**6. Main Ceremonial Chamber:** This is the site of all the important rituals that the cult performs. It is also the site of meetings that involve the entire membership of the cult.

To say that this room is hideous would be an understatement. Every detail of this room is derived from and devoted to evil.

The ceremonial chamber is 50' wide and 90' long. The cavern was hollowed out of the earth, then the

walls and ceiling were tiled with blocks of polished obsidian. The reflection of candle and torchlight off the tiles give the room an eerie, supernatural feeling. It also gives the room a strange, unearthly echo.

The floor of the cavern is made of slabs of black basalt, also highly polished. A long, black carpet runs the length of the main aisle in order to muffle the noise created by hard shoes and boots.

Despite the polished stone, the chamber is filthy. Dust and dirt lie everywhere, and webs fill corners and spaces beneath the benches and altar. The remains of herbs and incense lie on the floor, along with ash and black wax from candles and torches. Even dung from underground animals litters the floor.

The building materials for this chamber arrived slowly over a period of many months. They were carried in by cult members arriving from distant cities. A specialized magical item was created for this purpose, similar to a *bag of holding*. This item resembles a small crate and is capable of holding 3,000 pounds while weighing only 20 pounds. Once emptied inside the chamber, the crates were carried back out of the city to be filled and reused many times. None of the crates are stored in the complex.

Two visible doors provide access to the ceremonial chamber. One of these is the set of double doors that leads from the assembly room (area 5). The other is a single door at the back of the chamber and leads from the private meeting room used by the cult leaders.

There is a secret door in the front of the chamber, behind the uppermost of the three steps (described below). It is sometimes used in combination with smoke tricks to make dramatic entrances or exits. Only the cult leaders know of its existence and the mechanism



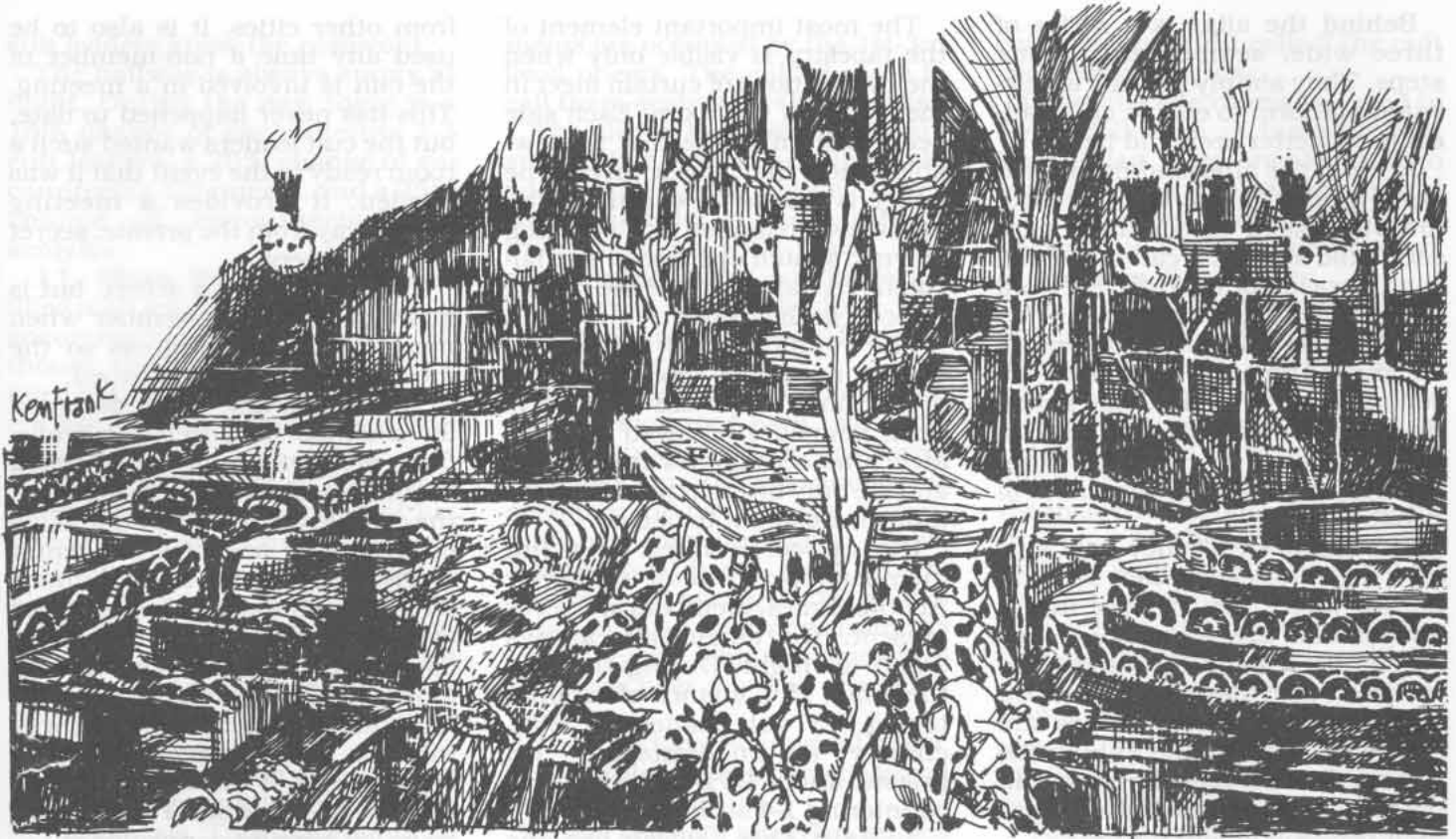
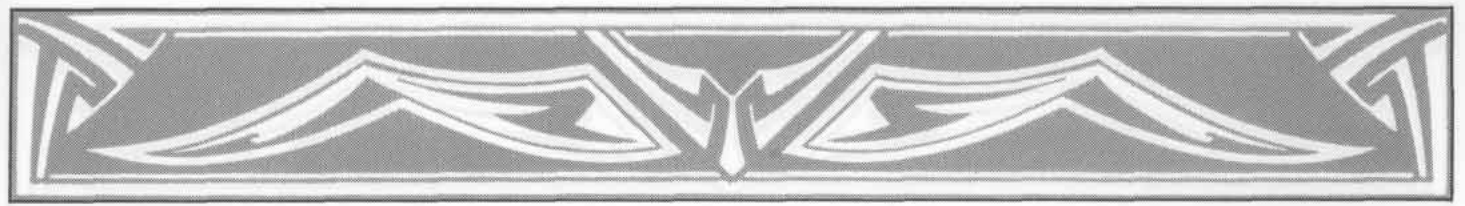

which activates it. From the chamber side, it is opened by two latches: one near the floor which is tripped with one's foot, and another at chest height between the cracks of the stone blocks. From the opposite side of the wall, the secret door is opened by pulling down on the lower jaw of a stone snake which hangs near the secret door.

Another unusual feature of this room is six holes in the walls approximately one and one-half feet in diameter. The holes are positioned at the point where the wall meets the floor. At first glance, they appear that they could be part of a drainage system or perhaps an animal burrow. The holes are obstructed (but not impassable) with dust, webs, and filth.

The holes lead to hollow sections behind the walls. Each section is home to one scryxull. The scryxulls attack upon verbal command, and despite the size and construc-

tion of the chamber and its inherent echo, those verbal commands are easily received.

The ceremonial chamber is eerie in its own right, but the furnishings here make it even more frightening. Long benches arranged in rows provide seating for the cult members; the carvings of the black, wooden benches depict faces twisted and distorted in pain and torture.

Distributed throughout the chamber are six large (4' diameter), bowl shaped drums. They are constructed of some type of blackened skin stretched over a bronze bowl, supported on tripods of large bones. Near each drum is a large bronze gong, hung from a frame built of bones. Twelve mallets of bone, padded with black hair, lie near each drum and gong.

Near the front of the room, an altar stands in silent testimony to the evil that dwells here. The altar has a black marble top deeply en-

graved with runes. It is supported on both ends by two more slabs of black granite, but these are nearly hidden by many blackened humanoid skulls. The skulls are stacked on top of each other with the largest skulls at the bottom.

Both ends of the altar are flanked by copper braziers in black wrought-iron stands. These give off a foul odor even when cold. They are used to burn incense and herbs derived from poisonous plants and noxious weeds, as well as the dung of humans and animals.

The room is lit by torches that line the walls at four foot intervals. Again, the evil of the cult is revealed in the features of the torch holders. Each torch is thrust into the hole in the base of an overturned skull that hangs on the wall. When lit, the torchlight fills the empty cavities of the upside-down skulls, making them appear alive and silently laughing.

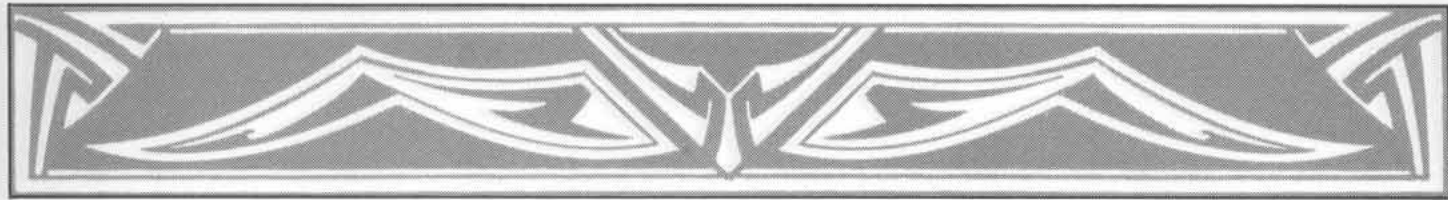

Behind the altar is a series of three wide, semi-circular stone steps. They simply provide an elevated platform to enable cult leaders to be better seen and heard.

Around the altar and positioned strategically on the steps are numerous black candelabra that each hold six black candles. Each candelabra is slightly different from the others; upon inspection, PCs will discover that these differences are due to the fact that they are constructed of bones, blackened by fire. The candles are held in small brass cups, but all other parts of the candelabra are made of bone.

The candles that they hold give off a foul odor even when they are not lit; when they are, the fumes and smoke are nauseating. For ceremonies which induct new members into the cult, special candles are used whose fumes are mildly hallucinogenic. This seems to help the new recruits believe in the powers of Iuz and reinforce their decision to join the cult.

Between the altar and the front of the stone steps is an enormous two-piece tapestry curtain. The curtain may be drawn to opposite sides of the room if desired. It is often used for dramatic effect, sometimes assembling the cult leaders behind the curtain then opening it with a bright flash and a cloud of smoke. Sometimes it is kept closed so that its portrait may reinforce the mission of the cult.

The tapestrywork of the curtain depicts a mural of death and destruction in the City of Greyhawk. Across its 50' width, various scenes depict citizens being slaughtered by followers of Iuz, fires raging uncontrolled, and lightning raining from the sky. Dark clouds hang over the city. The largest of the scenes depicts the destruction of the Sacred Temple of St. Cuthbert. The Temple lies in ruins and the bodies of its clerics litter the scene.

The most important element of the tapestry is visible only when the two sections of curtain meet in the center of the room. Each side bears half an image that is viewable when the halves meet. The image is that of an enormous falcon, claws extended as if reaching down to snatch up its prey. The falcon hovers at the top of the mural, directly in the center.

The chamber is otherwise empty; no papers, books, scrolls, or personal items are kept here. Such items are removed immediately after ceremonies are finished and are only brought in when ceremonies are about to begin.

During ceremonies, the full membership of the cult is present. At other times, members are never present. The chamber is always empty at night. During the day, there is a 15% chance of encountering 1-3 cult leaders, a 20% chance of encountering 1-3 priests, and a 25% chance of encountering 1-4 acolytes.

**7. Hall:** This hallway has one door on each end, and leads from the main ceremonial chamber to the stairway. It is lit by two torches near each doorway. The hall is otherwise empty. It is constructed in the same manner as the other hallway (area 3).

PCs will not encounter anyone in this hall.

**8. Stairs:** This stairway leads down into the cult leaders' private meeting room. Each step is built of a solid stone slab. The walls and ceiling are constructed of stone blocks similar to area 3. Two torches are placed on the wall at the top and bottom of the stairway and are lit only when necessary. The wall above the torches is blackened with smoke.

PCs will not encounter anyone in this room.

**9. Private Meeting Room:** This is used by the cult leaders for planning their strategy and holding meetings with agents of Iuz

from other cities. It is also to be used any time a non-member of the cult is involved in a meeting. This has never happened to date, but the cult leaders wanted such a room ready in the event that it was needed. It provides a meeting place away from the private, secret living quarters.

The room is not a secret, but is guarded by a cult member when meetings are in progress so the meeting will not be disturbed.

This is a simple room designed for a single purpose. The walls, floor, and ceiling are constructed of stone blocks similar to area 3 of the complex. A wooden table of average quality occupies the center of the room, and it is surrounded by ten wooden chairs bearing seat cushions. No files, cabinets, or cupboards are in the room; it is left empty so that nothing incriminating could be misplaced or find its way into the wrong hands. Two ordinary bottles of ink and four quill pens lie on the table. These are always left here for convenience.

A *priest locked* secret door (see the New Magic appendix at the end of this module) is in the northeast corner of the room. It leads to an empty secret room, and was built to be used as a hiding place only in emergencies. All the priests but none of the members know the password to this door. It is never used.

PCs will not encounter anyone in these rooms.

**10. Hallway:** This is similar to the hallways described previously. They are accessed via the secret doors indicated on the map. Oil lamps hang in sconces on the walls at 15' intervals. The walls above the lamps are streaked with a cone of black soot.

The northernmost door in this hallway leads to the private quarters of the cult's leaders. It is *priest locked* (see the description in the New Magic appendix at the end of this module) and only the three





cult leaders know the password.

The hallway is always empty at night. During the day, there is a 15% chance of encountering 1-3 cult leaders, a 20% chance of encountering 1-3 priests, and a 25% chance of encountering 1-4 acolytes.

**11. Mess Hall:** This room is filled with long tables and chairs to accommodate 40 people. Although the room has never been filled to that capacity, the cult leaders are certain that the cult will grow.

The room is bare except for a plain wrought iron symbol of Iuz directly opposite the doorway.

The mess hall is always empty at night. During mealtimes, all residents of the complex are present. There is a 5% chance that the cult leaders will hold a meeting in this room with all priests and acolytes in attendance.

**12. Kitchen:** The acolytes are required to share kitchen duty on a rotating basis. This room contains tin plates, cups, and bowls, silverware, cooking utensils and equipment, two wood-burning stoves, and a sink. Fresh water is carried in, and wastewater is simply dumped into the sewers.

The amount of food found here varies with the frequency of the ceremonies. Cult members are expected to bring donations of food to every meeting and ceremony to support the priests. Those who are merchants, such as butchers and bakers, usually bring their wares. Other members purchase salt, sugar, spices, and other necessities to keep the pantries filled.

The kitchen is always empty at night. During the day, 1-4 acolytes are present two hours before and one hour after meals. They are assisted by the four *charmed* abductees from Shacktown. See the "Guest Chambers" description that follows for more about the abductees.

**13. Acolytes' Cells:** These

rooms are occupied by the 1st-3rd level priests. The cult chooses to call them acolytes at these levels.

The doors to these rooms are sturdy but are not designed to withstand much force. They would splinter if they suffered more than 2-4 solid blows. The doors do not have exterior locks, but have a simple deadbolt lock that can be operated only from the inside.

Two acolytes share a room; each room is equipped with two beds, two chests of drawers, one wardrobe, two small chests, and an assortment of torches, oil lamps, quill pens, writing paper, books, and personal items. Each acolyte possesses an average of 50 gp, distributed as an allowance from the cult's income. This sum indicates a savings over a period of several weeks.

Acolytes have no magical items. Nothing else of value may be found in their rooms.

These cells are always occupied at night. During the day, there is a 25% chance of encountering one or both the occupants of the room.

**13A. Priests' Cells:** These are the sleeping quarters of the 4th, 5th, and 6th level priests. The rooms are occupied by only one priest, and are furnished similarly to the quarters of the acolytes but have only one bed. If a room is available when a priest reaches 4th level, he is allowed a private room.

The priests who occupy these rooms have possessions similar to the acolytes, but own 80 gp and one magic item each. For a description of these items, see the character descriptions in the chapter which details the cult.

These cells are always occupied at night. During the day, there is a 25% chance of encountering the occupant of the room.

**13B. Guest Chambers:** These rooms are unoccupied and serve a variety of purposes. They will be

converted to priest cells if the cult ever expands in size.

Currently, the rooms are used to house followers of Iuz who visit from Molag. They are also used to isolate priests who become ill, and the rooms could also serve as a holding cell for intruders who are captured in the complex.

Each room contains two beds and two chests of drawers, a large chest, a wardrobe, a writing table, and two chairs. The doors to these rooms are sturdier than those on the doors of the other priests' cells, but have only a deadbolt lock on the inside of the door. In the event that one of these rooms would serve as a prison, the doors would be nailed shut.

There is a 10% chance that one of these rooms is being used by a visiting cleric. If the DM determines that one of the rooms is in use, he should add personal belongings similar to those of the cult priests to the room.

Two of the rooms are currently occupied by abductees from Shacktown. Two women share one room, and two men (one is the juggler whose diary the PCs located) share another. The cult abducted these people to serve as slaves, and keeps them under the influence of *charm* spells at all times. If ordered to attack, they stand confused and do not enter into battle.

**14. Priests' Study:** This room is filled with tables and chairs. Bookshelves line the walls, filled with every imaginable subject from geography to astrology. Books about Iuz abound, discussing the worship of him, some of his more famous clerics, legends, and histories of his cults.

None of the information about the original cult is kept in this room. Those items are considered extremely valuable and are stored in a secret vault in the cult leaders' study. All information about the original cult is passed on to cult members verbally, and no one but

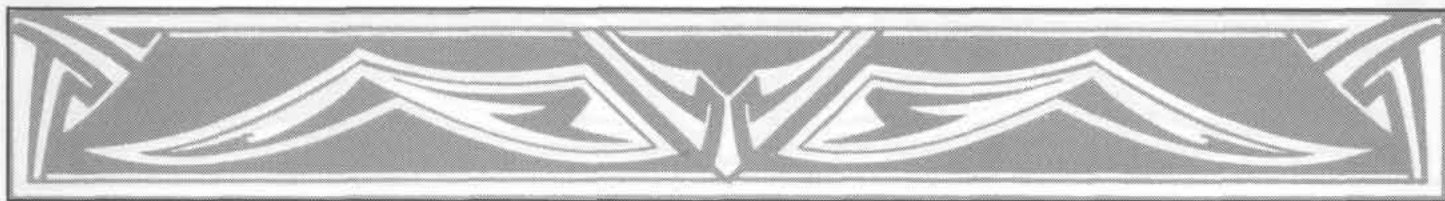

the cult leaders is aware of these documents.

This study is available to all priests and acolytes who desire a place for quiet work. The room is occupied 65% of the time by 1-2 priests and 1-2 acolytes.

**15. Priests' Meeting Room:** This room is available to any priests who desire a place for discussion. It contains a large, round table and ten chairs but is otherwise empty. The room is used for meetings and discussions but also for social gatherings and cardgames.

The secret doors that provide access to this room are merely deterrents and are not intended as defenses. The secret door leading to area 10 is frequently left open when the room is not in use.

The meeting room is occupied 40% of the time by 1-4 priests and 1-4 acolytes.

**16. Private Hallway:** This hall accesses the private quarters of the cult leaders, their private study, and the secret door at the rear of the ceremonial chamber. All entrances to this hall are *priest locked* and only the entrance from area 10 is known to the priests.

The hallway is identical to area 10. Oil lamps hang in sconces on the walls at 10' intervals, and the walls are stained black from the smoke. Between alternate sconces are a variety of sculptures depicting snakes. The six snakes are portrayed in various activities from devouring prey to sleeping with one eye open to battling other snakes. The sculptures are made of a variety of materials including gold, bronze, iron, and wood. The sculptures are worth a total of 1,000 gp and are not magical.

The two snake sculptures nearest the secret doors serve as the triggers for the secret doors. The door to the east is tripped by pulling down on the lower jaw of the snake sculpture nearest it, and the door to the west is triggered by

pressing a scale in the tail of its nearest snake.

The hallway is usually empty. There is a 10% chance of encountering 1-3 cult leaders.

**17. Cult Leaders' Private Study:** This room is used only by the cult leaders. It contains three long tables and three black leather chairs, and the walls are lined with bookshelves. This room holds all the important records and historical information about the cult. The cult leaders discuss all their secret strategies here, and hold meetings to discuss the cult's progress and review the activities of the priests, acolytes, and members.

A vault in this room holds the cult's treasury of 1,500 gp and four of the cult's pendants (three bronze and one silver). It also holds a *book of vile darkness*. Only the cult leaders know of the book's location.

The door to the vault is locked and held with three separate *priest lock* spells. Each password is different, and the three passwords must be spoken to open the door. Each cult leader knows only one password.

The door to the study is a stone slab. It is always kept locked, even when someone is inside the room, and the door also bears a *priest lock* whose password is known to all three cult leaders. It is inset with a lock that must be operated when exiting as well as entering the room.

There is a 25% chance of encountering 1-3 cult leaders in his room.

**18. Private Quarters of Embar Dessid:** The door to this room is built of heavy oak and is reinforced with bands of iron. A complex lock is set in the door. A *priest lock* spell also helps to keep out intruders, and the password to this spell is known only to Embar.

The room contains a comfortable bed, a wardrobe, bookcase, desk and chair, two chests of drawers, and one large and one

small chest. A black carpet with a geometric maroon design covers the entire floor.

The most striking feature about the living quarters is the seven skulls and two human heads which decorate the walls. Most of them are recognizably human, elven, and dwarven, but a few are not recognizable as any known race. Most of the skulls are intact, but a few are crushed or split. Three skulls and the two heads hang from nails or spikes in the wall, while the other four are mounted on plaques of wood. Two of these bear a small metal tag with the deceased's name.

A gruesome but common custom among followers of Iuz, these are trophies of former battles. The respect that a follower of Iuz commands from other followers is in direct proportion to the number of trophies he has collected.

Embar has improved his collection by animating the two heads and three of the skulls. When anyone (including himself and the other cult leaders) enters the room, these skulls begin to chatter their teeth loudly and the heads moan. This continues until Embar speaks a command word to silence them or they are destroyed.

A large tapestry hangs above the bed. It is similar to the enormous curtain in the ceremonial chamber, but its scene is that of a falcon seated atop an unholy symbol of Iuz.

The bed, wardrobe, and bookcase are ordinary and contain nothing unusual. The two chests both have false bottoms and contain 75 gp each. The chest of drawers holds an assortment of black clothing, a variety of herbs and incense, and teeth that appear to be those of various animals. Twelve black candles can be found in the bottom drawer.

The desk contains an assortment of papers including notes about the cult, recommendations



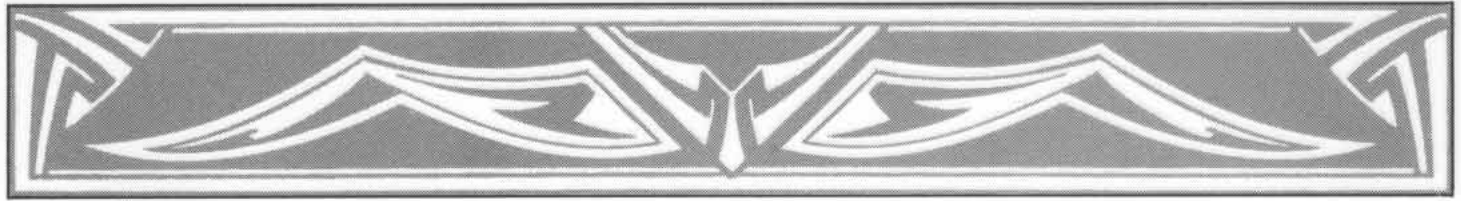

about new members, and progress reports about some of the priests and acolytes. Several letters can also be found that appear to be written by a cleric in Molag. This cleric has been providing Embar with secret information about Iuz's cult there, in order for Embar to strengthen the cult in Greyhawk. The letters also make reference to supplies that were smuggled into Greyhawk along with the building materials.

Embar is not working against his colleagues, as the letters could suggest. Rather, he is the contact with the cleric in Molag whom the cult leaders have come to rely on heavily. If the cult ever becomes powerful and wins the favor of Iuz, Iuz will probably expand the cult in Greyhawk. The current cult leaders plan to ask for their cleric contact in Molag as an assistant. No doubt this cleric is expecting some sort of favor when the time comes.

The desk also contains a secret drawer that contains two pieces of *incense of meditation* and one *potion of flying*.

If the PCs lift or roll the carpet back, they find an enormous unholy symbol of Iuz painted on the floor. They also find a secret trapdoor that leads to a pit in the earth. The pit is 8' deep and 5' in diameter. Its sole purpose is to provide a hiding place in the event of an attack on the lair if there is no means of escape. The pit is tiled in stone on the floor and walls. An ordinary cloak hangs from an iron hook in the wall.

This chamber also contains all of Embar's personal belongings, including his ceremonial robe. The robes of the cult leaders are distinguished by a strip of black fur trim around the hood.

Embar Dessid owns a *mace +1*, whip, chainmail, and a wooden shield. He owns a *rod of terror* and a *dagger +3* that has a hollow poison chamber. This dagger is al-

ways with him, and is within arm's reach when he is asleep.

Embar is always here at night. There is a 10% chance of encountering him here during the day.

**19. Private Quarters of Mara Zonin:** The furnishings of this room are similar to area 18. The door is identical to the door of area 18 and is protected by a *priest lock* spell whose password is known only to Mara.

The bed and wardrobe are ordinary and contain nothing unusual. The large chest has a false bottom that contains 75 gp. The small chest holds a suit of *chainmail +1* that was obviously designed for a woman's body. It also holds a scimitar, flail, a bronze shield that bears the unholy symbol of Iuz, and a *staff of kitsyrral*, which is described in the new magic appendix at the end of this adventure.

Mara also owns a *ring of earth elemental command* which she wears at all times.

The chest of drawers contains a variety of women's clothing and a pouch containing 25 gp. The bookshelf contains ordinary books except for one false book that holds incense and herbs. The desk is home to many papers similar to those in room 18: reports, letters, notes, and comments about the cult's progress. A secret drawer contains one *potion of healing* and one *potion of invisibility*. The bottom desk drawer holds eight black candles.

The carpet is charcoal grey with dark green and black splotches. A tapestry that resembles the curtain in the ceremonial chamber hangs from the wall. This tapestry depicts a giant falcon crushing a miniature version of the City of Greyhawk.

If the PCs lift or roll the carpet back, they find an enormous unholy symbol of Iuz painted on the floor. They also find a secret trapdoor that leads to a pit in the earth.

The pit is 8' deep and 5' in diameter. Its sole purpose is to provide a hiding place in the event of an attack on the lair if there is no means of escape. The pit is tiled in stone on the floor and walls. A folded blanket and two candles lie on the floor in the pit.

Ten skulls hang from the walls in Mara's room. Six are mounted, and three have nameplates.

Mara stores her ceremonial robe in this room in a special section of the wardrobe.

Mara is always here at night. There is a 10% chance of encountering her here during the day.

**20. Private Quarters of Zembak Narsa:** The furnishings of this room are similar to areas 18 and 19. The door is identical to the door of area 18 and is protected by a *priest lock* spell whose password is known only to Zembak.

The wardrobe, bookcase, and small chest are ordinary and contain nothing unusual. The bed has a secret compartment under one of the large, round bedknobs. The compartment holds one *vial of oil of slipperiness* and one *potion of flying*.

The large chest has a false bottom that contains a pouch of 60 gp. The large chest also holds Zembak's ceremonial robe.

The chest of drawers holds clothing, seven black candles, incense and herbs, a pouch containing 50 gp, and an ordinary gold ring set with a black stone worth 50 gp.

The desk is a mess, but contains papers similar to those in rooms 18 and 19. One document stands out as important: it is a report from the cult's spies describing the activities of the PCs. It begins with a physical description from the first day they arrived in town, and details nearly every activity since. Some gaps are present if the PCs entered the sewers (i.e., if a cult member did not follow the PCs underground, there is no description

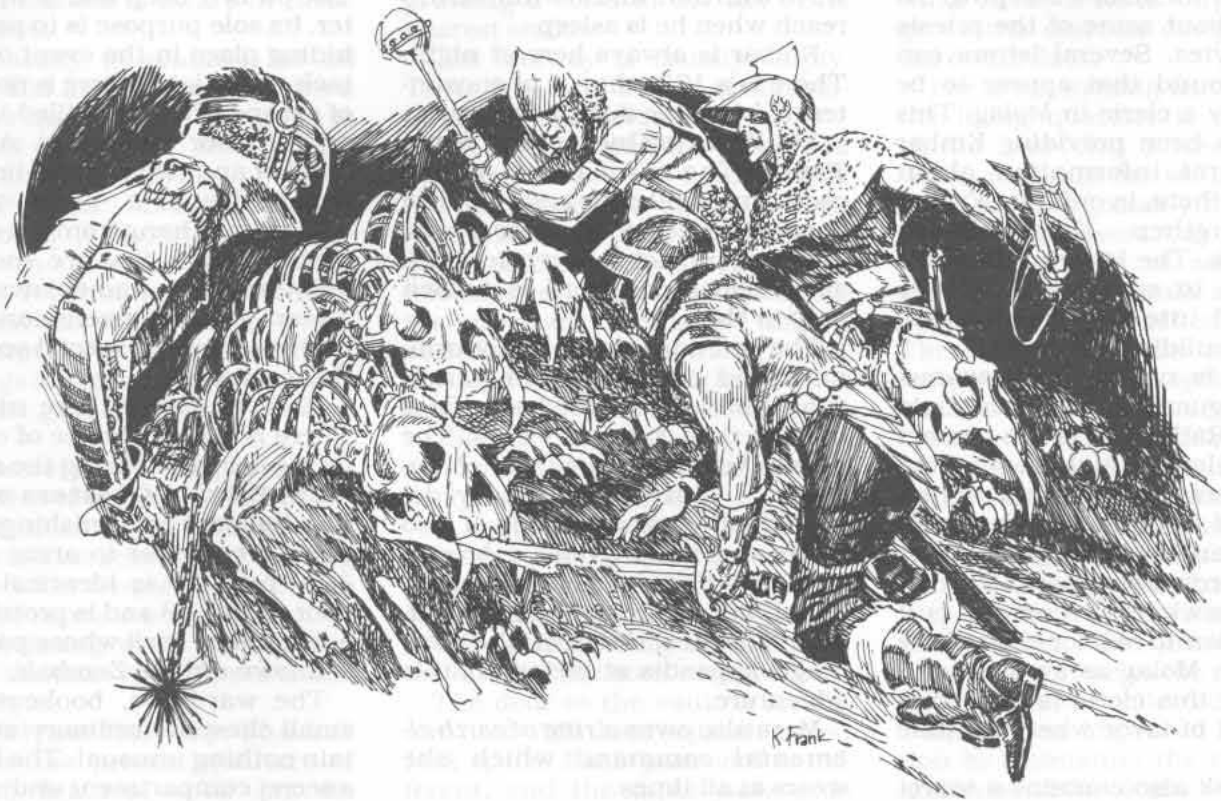
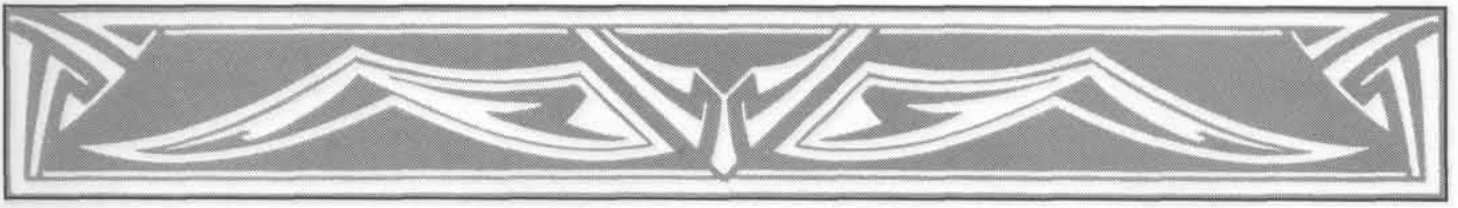

of their activities there).

The carpet in this room is blood-red. If the PCs lift or roll the carpet back, they find an enormous unholy symbol of Iuz painted on the floor. They also find a secret trapdoor that leads to a pit in the earth. The pit is 8' deep and 5' in diameter. Its sole purpose is to provide a hiding place in the event of an attack on the lair if there is no means of escape. The pit is tiled in stone on the floor and walls. It is empty except for a porcelain jar filled with water and a blanket.

A tapestry similar to those described previously depicts a falcon breaking free of web-like bonds. The tapestry hangs above the desk from a cord looped over a leering skull.

Twelve skulls hang from the walls in this room. Six are mounted and three have nameplates.

Zembak owns a *scimitar +1*, a mace, chainmail, a shield, and a

*staff of withering*. These are stored in the wardrobe under a woolen blanket. He also wears a *necklace of adaptation* which he never removes.

Zembak is always here at night. There is a 10% chance of encountering him here during the day.

**21. Falcon's Quarters:** This room has been prepared to be home to the Falcon when she is freed by the cult. The room has been ready for several months.

The largest living area in the complex, this room was designed for a regal occupant. The priests chose the finest items they could find for this room, and the quality of the furnishings surpasses those of the rest of the complex.

The bed could sleep three persons comfortably. The mattress is filled with black down and is nearly one foot thick. The bedposts are carved of black wood and depict snakes coiling upward around the posts. A canopy of

black velvet drapes above the bed.

The wardrobe is also elaborately carved and is outfitted with a small lock. The key rests in the keyhole since the room is without an occupant.

The dresser holds several new robes, nightgowns, tunics, and other garments. These were crafted by the cult's tailor, and although the Falcon's exact appearance was unknown, the cult leaders decided to have a few articles of clothing ready for her arrival. These are made of the finest fabrics available, including black silk and velvet.

The room also contains two large, empty chests. Both have false bottoms but are empty. A large desk stands against one wall and holds parchments, quill pens, ink, and black sealing wax, but no important papers or documents. The desk drawers are empty except for a dozen black candles and a tinder box and flint.



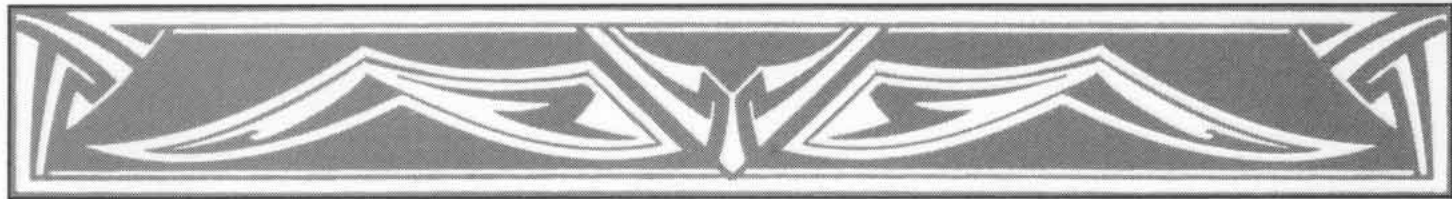

The carpet covers the floor completely and is woven in a black background which is covered by red snakes. The snakes are carpet snakes and will attack anyone in the room if they are activated.

**Carpet Snakes(20):** AC 5; MV 15; HD 3; hp 18; #AT 1; Dmg 1-3; SA poison; SD none; AL CE; THACO 17.

The carpet snakes were pilfered and smuggled into Greyhawk by the cleric in Molag. The snakes are rare, but a large colony is kept in the temple of Iuz in Molag. Iuz has established a breeding facility for carpet snakes and keeps perhaps 200 of them in his temple.

The cleric in Molag stole three mated pairs of the snakes and sent them to Greyhawk. Here, they have been bred by the cult and

their number has increased to twenty. The carpet snakes are present only in this room, but when the number becomes large enough, they will be added to other rooms as well.

Carpet snakes can be trained to recognize up to five masters. They can be taught to obey these persons and will protect them, and will also attack their enemies. They can also be trained to attack or cease attack on command.

The carpet snakes in this room recognize the three cult leaders as masters and will not attack them under any circumstances.

The carpet snakes will begin to form when they sense an intruder, but to ensure this, a *magic mouth* has been placed on the door to activate the snakes. The *magic mouth* is triggered by anyone who passes through the door without speak-

ing the password of the *priest lock* spell. The *mouth* says simply, "Intruder. Intruder. Intruder" in a calm but firm voice. The message is designed to animate the snakes, which will begin forming immediately.

Beneath the carpet is an enormous unholy symbol of Iuz and trapdoor and pit similar to those described previously. This pit holds a cloak, blanket, candles, decanter of water, a large cushion, and a wooden stool.

No armor or weapons can be found in the Falcon's quarters. The cult leaders were unable to anticipate her needs for this equipment.

During the day, PCs have a 5% chance of encountering 1-3 cult leaders in this room who are checking to make sure that everything is in order.





## 8: The Spurned Cult of Iuz

The cult of Iuz that currently threatens the City of Greyhawk is a descendant of the cult that was destroyed by Talar Thraydin many years ago. Although the Cult's leader, the Falcon, was imprisoned and her assistants were killed, some of the followers banded together to rebuild what they could of the cult.

These self-appointed leaders salvaged what they could from the cult's possessions and spent nearly one full year poring over notes about spells and the powers of Iuz before they began planning the revival of the cult. Their planning required several months before they felt confident that they could proceed and be successful. This length of time also allowed some of the uproar caused by the cult to die down.

Although most of the information about the cult was kept secret by the clerics of St. Cuthbert, rumors and speculations were still widespread. Superstitious and gossip-hungry citizens managed to keep the cult stories alive for nearly a year after the cult's downfall despite laws to the contrary. Evil cults are strictly forbidden in the City of Greyhawk, and simply discussing them or spreading gossip is punishable by a heavy fine. This did not stop the rumors for a long time, to the cult's disappointment.

The new cult leaders learned through their research that the Falcon was sent to Greyhawk to build a new cult of Iuz. She was greedy for power and saw this as an opportunity to gain the favor of Iuz and possibly a position as a high-level assistant.

This greed, however, was the Falcon's downfall. By wanting too much too soon, she made many

critical errors that betrayed the secrecy of the cult and left her vulnerable to the plot against her. Had she taken her time and planned carefully, the cult would have grown, rather than being destroyed in its infancy.

Another of Falcon's mistakes was in choosing her followers. She preyed on teenagers for their vulnerability, naivete, and the ease with which they could be manipulated. She did not count on the concerns of their parents or the lack of commitment of some of these young members, who eventually became fearful of the cult and wanted it stopped. They provided the vital clues that allowed Talar and his party to attack.

During the course of their research, the new cult leaders travelled to the lands of Iuz north of the City of Greyhawk. They reached Molag, the city from which Iuz rules his territory on Oerth. There, they asked for assistance in reestablishing the destroyed cult. Although they were congratulated for their initiative, they were denied any favors. The leaders were told that if they could prove themselves worthy, they might receive support from Molag. But since the cult had ended in disaster, Iuz was not willing to waste time and resources on bunglers.

### Iuz's Vendetta

Iuz decided to monitor the progress of the cult, however, since he had a score to settle with Greyhawk. He had been trapped for decades in a chamber beneath Greyhawk Castle by the mad arch-mage Zagyg. When his prison was sprung, attempts were made on his life by a party of Greyhawk's citizens, including Tenser, the

arch-mage. Iuz would like nothing better than to see Greyhawk ruined and converted to his own territory.

Iuz would eventually learn that members of the cult had infiltrated important public offices in Greyhawk. Upon learning this, he decided that these cult leaders were serious about their efforts, and assisted them by providing them with the building materials necessary to construct their underground temple.

Iuz's position is that if this cult is successful in its efforts in increasing its membership and infiltrating the government of Greyhawk, he will reward them and use their hard-won power to settle his vendetta with the unsuspecting City of Greyhawk. If they fail, however, he will refuse to recognize them ever again. When the time comes to confront Tenser and the city, he will do it according to his own plan and using his own means.

### Growth of the Reborn Cult

When the new cult leaders were ready, they began their carefully planned efforts to revive the cult even though Iuz had refused to assist them. They were determined to win his favor and succeed where their predecessors had failed.

They recruited only the most loyal and trustworthy of the original cult members. The new cult was extremely selective and cautious in their recruiting efforts, hand-picking their members. Before a recruit was approached about joining the cult, he was watched for several weeks to determine whether he was the "right material." Nearly half the recruits



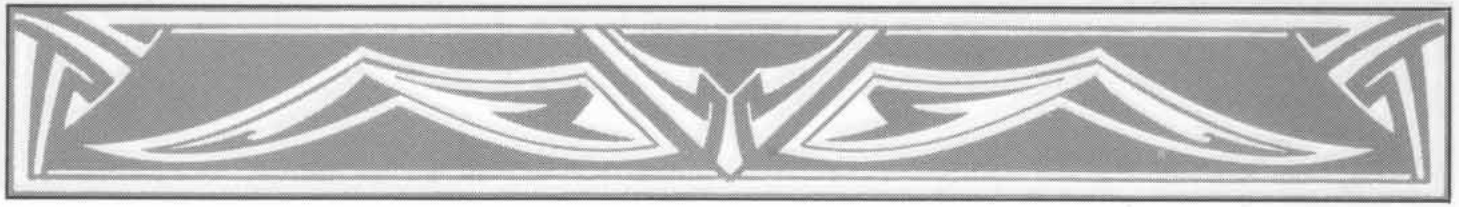

who were watched were never offered membership because the cult had become so selective. These people never even knew of their potential as cult members, so cautious was the acceptance process.

Of those persons offered membership, only a few, perhaps 5%, turned down the offer. Unfortunately for them, they paid with their lives. Their bodies were never found and their bones now decorate the cult's underground lair.

Membership grew slowly, gaining perhaps a four members per year, but all members were strong in their commitment. They swore an oath of secrecy that they would carry the knowledge of the cult to the grave.

As the years passed, the original cult members passed away and the positions of leadership were assumed by other members, sometimes by vote, and sometimes by decree of the other leaders. Sons and daughters of the members were frequently inducted into the cult as they reached adulthood. For the most part, however, members were unmarried, to avoid the suspicion of spouses and children. Several marriages did result between members of the cult who met as a result of their cult activities. The children of these marriages were declared members of the cult before their birth and attended cult activities with their parents as soon as they were born.

The cult became serious in its efforts to infiltrate the city. The leaders pinpointed important positions that they hoped to one day control. They knew that these efforts could take years, waiting for promotions that might come only after the death of key persons. The leaders knew that they could see to the deaths of individuals who stood in their way, but they wisely decided to let nature take its course rather than risk revealing their plot and endangering the cult.

With its goal of increasing their power and winning the favor of Iuz, the cult would stop at nothing. They knew that if they could strengthen the cult to near invulnerability, Iuz would favor them and endow them with powers beyond their dreams.

When Iuz recognized the cult's success in infiltrating the city government with a reward of supplies for building their temple, the cult was elated and their hunger for power was fueled. This served as incentive to increase their efforts and commitment to making the cult the most powerful in the Flanaess.

By the time forty years had passed since the cult's original destruction, all original cult members had died. Those in power had learned much, but felt that they needed some great, powerful deed to win Iuz's favor. They also felt that they needed some agent to help their cause, since their resources and knowledge of power were limited. They devised a plan to accomplish both these goals.

The cult leaders began to investigate their original leader, who had come to be known as the Falcon. They studied her writings that had survived since the destruction, and guessed that she must have been a brilliant and powerful leader. Unfortunately, in her personal writings, the Falcon portrayed herself as far more brilliant than she actually was. Her notes also did not reflect her greed for power that ultimately caused her mistakes and her downfall.

The new leaders realized that she probably had not been destroyed, as perviously thought, but trapped in some sort of dimensional prison. They decided that this was the opportunity they had been waiting for; if they could free the Falcon, they would accomplish a great deed and gain an agent of Iuz who could lead the way to power under Iuz. With the

Falcon to lead them, they thought, they could surely take over the City of Greyhawk, claim it for Iuz, and run the most important city in the Flanaess.

## Current Ambitions

As the PCs will eventually discover, the cult has researched the magic that trapped their former leader. They have already made several unsuccessful attempts to break the magic that holds her. They will continue these efforts and will eventually be successful unless they can be stopped in time.

As they have come closer to freeing the trapped Falcon, the cult has taken steps to ensure that they can operate undisturbed. They have threatened or ambushed many adventuring parties that have come to Greyhawk in order to drive them out of town, lest they discover the cult. They have also threatened or killed citizens of Greyhawk who stumbled onto their plans and threatened to reveal them. And they have set fires and launched attacks around the city to provide a diversion for their activities and keep the law busy elsewhere.

The cult knows that they are not yet strong enough to challenge the clerics and the Temple of St. Cuthbert. This is the reason that the Temple has not detected their activities. They have, however, had their eye on Talasek for a long time. They know that a man of his dedication can cause them problems simply because of his commitment to any cause he champions.

One of the cult's minor mistakes was in kidnapping residents of Shacktown to be *charmed* and used as slaves. They were aware of the shrine of St. Cuthbert there, but were not aware of Nicholi's undying dedication or his friendship

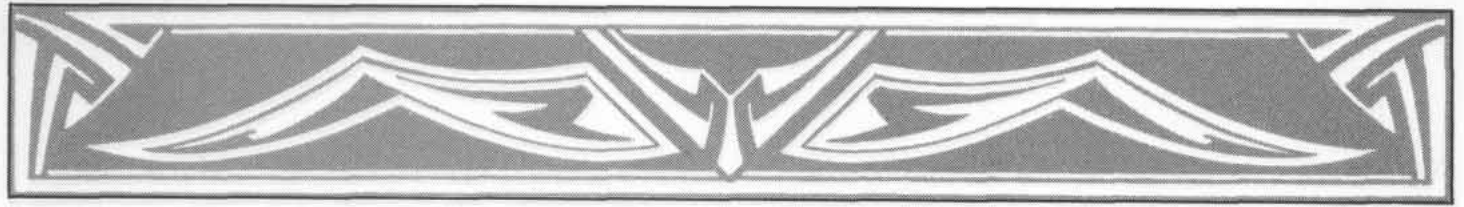

with Talasek. This link will provide clues to the PCs that the cult cannot afford to have revealed.

The cult has spies all over the city. Although they are not nearly as thorough as the Thieves' Guild at watching the activities in Greyhawk, they remain abreast of activities that are of concern to them. All cult members are required to report on any adventurers they see entering the city. The cult then keeps a watch on them. If adventurers appear to come close to any hint of the cult activity, they are threatened or ambushed to encourage them to leave the city.

As mentioned, the cult also watches Talasek. Until he met the PCs, the cult saw no reason to threaten him, but his relationship with adventurers gives the cult cause to worry. This is the reason for the attack on Talasek after he hinted to the PCs of mysterious happenings in the city.

As adventurers persist in investigating the activities of the cult, the threats and attacks on them become more violent. However, the cult tries to stop short of killing their enemies in such attacks, because a murder would spark more investigation than a street brawl. The cult cannot allow the risk of being discovered in such a manner.

The cult's plans are to continue trying to free the Falcon. This activity takes priority over all others unless the cult is directly threatened and must defend itself.

The cult has recently hosted several of the members of Iuz's personal cult from Molag. These are the visitors that can be observed entering and eventually leaving the city at night, carrying heavy bundles. Although most of the stone for the temple has already arrived and been put in place, these visitors carry the last of the stone that will finish the underground complex. The stone is carried in a crate that is similar to a

*bag of holding*, but is capable of holding 3,000 pounds while weighing only 20 pounds.

The visitors normally stay with the cult for a few days to rest for the journey home. This also gives them an opportunity to observe the cult and provide Iuz with a report on their progress when they return.

## The Cult's Pendants

Through a variety of encounters, the PCs learn that cult members wear a symbol of the cult that identifies them as members. Although these are not displayed openly, they are not hidden, either.

The pendant is designed to look like a stylized claw of a falcon, but it is smooth and rounded rather than being an exact replica of a claw. It is designed in such a way that a casual observer would not immediately recognize it as a claw.

The pendant is designed to be a form of recognition for cult members and also to designate one's status in the cult. Members wear a simple version of the pendant cast in bronze. Clerics wear a silver pendant of the same style as the members. High level priests wear a gold pendant that has a small black stone inlaid in the center talon. The three leaders of the cult are recognized by their gold pendants that are inlaid with large black stones on the tip of each talon.

The pendants are not magical, but are imbued with a strong aura of evil. Part of the reason for this evil aura is to ward off guardian creatures in the lair that attack good creatures. The evil aura of the pendants helps to ensure that no mistake is made by the monsters.

Every cult member owns a pendant. Pendants are commissioned from a jeweler as needed, but a few extra are kept in the quarters of

the cult leaders. The pendants of the three cult leaders are the only ones of their kind; these are handed down to new leaders rather than commissioning new ones. The leaders believe that this will strengthen the pendants as they absorb evil and in turn, strengthen the cult leaders.

The pendants are commissioned from a local jeweler named Goldie (see the description of the marketplace). Goldie is under strict orders not to ask questions or offer information to non-members about the pendants. He has sworn never to use the design for other jewelry. He knows that if his benefactor would learn that Goldie betrayed him in any way, Goldie would lose the pendant business. In reality, Goldie would probably lose much more than just the business.

One of the high priests of the cult is responsible for commissioning the pendants. Goldie recognizes him on sight but knows nothing of his business or even whether he is a native of Greyhawk. Goldie assumes that since he never sees the man in town, he must live elsewhere.

Goldie was chosen to make the pendants before the cult had a jeweler as a member. As soon as a jeweler becomes a member of the cult, Goldie will more than likely lose the cult's business.

## The Infiltration

Members of the cult hold many positions of importance around Greyhawk. PCs will meet some of them throughout the adventure, but might never suspect that they are cult members.

**Nestor Morden, Deputy Constable:** Nestor is a tall (6'3"), gangly man. He has black hair and dark, intense, beady eyes. He wears black trousers and a red shirt with a black half-cloak over



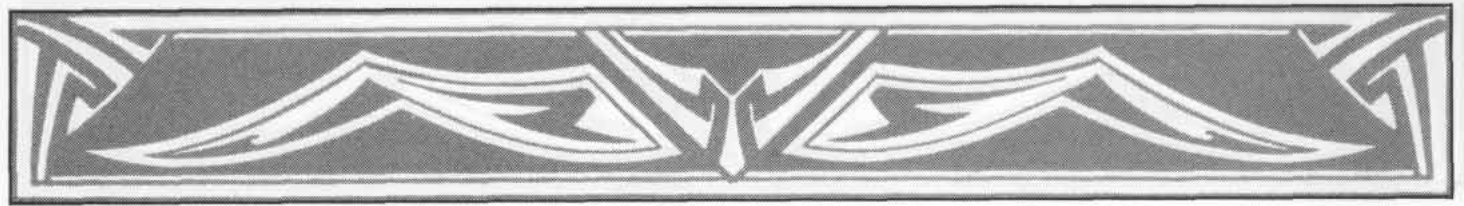

all. Black boots rise up to his knees. He walks with a barely noticeable limp.

Nestor has held this position for three years. He worked his way up through the ranks of the constables, having served in the City Watch for twelve years in varying levels before his promotion to his current position.

Nestor is alert to complaints of cult activities. If he discovers a cult other than his own, he will initiate the proper procedures to dissolve it. When complaints of cults come to the Citadel, he insists on handling them personally. He has convinced Derider Fanshen, the Chief Constable, that he has a personal dedication to the elimination of cults and wants to be in charge of monitoring all such cases. He has been so convincing that Derider has agreed to turn all such cases over to him.

Derider trusts Nestor implicitly and has never found reason to distrust him. If Nestor knows of persons who could blow his cover as a cult member, he tries to have them eliminated. If someone does get to Derider with a tip that Nestor is a cult member, Nestor lies so convincingly that Derider trusts him and decides that the accuser is probably a lunatic.

**Scarm Jenns, Dwenn Hyer, and Finx Klimm, Members of the City Watch:** These men are city guards who Nestor relies on heavily. They report to him of anything unusual in the ranks of the guards or any rumors about the cult.

Naturally, Nestor has only good things to say about these men when they are in position for promotion. He would like to see them move up in the ranks so they may better assist him.

One of the most important aspects of having these men at his disposal is that Nestor can see to it that the men are scheduled on dif-

ferent shifts. In this way, they can ensure the best possible coverage of the activities in the Citadel. With the four of them watching the other guards and listening for complaints, there isn't much that slips by them.

**Kuppis Deezen, Aide to the Mayor:** Kuppis holds an interesting and important position that the cult relies on heavily. He has access to information such as locations in the mayor's office, files and records, future plans of the mayor, and general information about the city.

Kuppis began working for the mayor's office as a messenger when he was fourteen years old. Since that time, he has worked his way up through several positions.

The mayor has four aides who attend to all types of business and errands. One is the Chief Aide, who is closest to the mayor and directs the activities of the other aides. The other three, including Kuppis, are of equal status but varying seniority. His colleagues have both held their positions for nine years, while Kuppis has held his for four.

Kuppis is a scholarly looking man who wears wire glasses at all times. He is of average height and build, and has straight, brown hair and blue eyes. His appearance is mild and not the least bit threatening, but Kuppis can be most effective in keeping unwanted guests out of the mayor's office when necessary.

Kuppis is always alert for complaints about cult activities in the city. He makes certain that if complaints come in, they are directed to Nestor at the Citadel. Nestor always issues a report claiming that his investigations turned up nothing (unless, of course, a different cult is discovered). Kuppis keeps a file of these reports so they may be referred to if necessary.

Kuppis has convinced his fellow

aides that Nestor is so good at investigating complaints about cults that it would be a waste of time to track them down themselves. They willingly direct all their cult inquiries to Nestor.

## Guildmembers

The cult also has members in each of the guilds in Greyhawk. There are three members each in the Assassin's, Sewermens', and Thieves' Guilds, two cult members in the Gravediggers' Guild, and one member in each of the other Guilds in Greyhawk. See Chapter 4, FFF, for more information about the Guilds.

These Guildmembers are responsible for detecting any rumors of cult activity that might arise within the Guild. The cult notifies Nestor and Kuppis if any rumors arise so they may be ready if someone reports the cult to the authorities.

## Citizens of Greyhawk

The cult also makes frequent visits to Shacktown to see whether any potential members may live there. Two residents of Shacktown have been successfully recruited to be priests of Iuz. The Shacktown residents that were kidnapped, however, were taken against their will and are used as slaves.

All the cult members except the priests lead normal civilian lives and live in boardinghouses or their own homes. A few of the cult members have families, and as mentioned earlier, a few were married as a result of meeting in the cult.

## Present Activities

All the priests in the cult live in the underground lair. Their needs are provided for by tithings paid by the cult members and by stolen goods obtained by the cult's



thieves. The priests are more than comfortable and do not lack for anything.

The cult also sends a percentage of its income to Iuz. Although Iuz did not demand it of this group, he demands it of his other cults. The leaders of this cult decided that paying a portion of their income to Iuz would increase his favor with them and possibly their power. They also feared that Iuz would ask for monies owed dating back to the cult's organization if Iuz ever formally recognized them as one of his cults. Every month, a messenger is sent to Molag to deliver the cult's tithing to Iuz.

The PCs must discover that the cult plans to repeat their ceremony until they free the Falcon. They have come very close to breaking her free of her prison, but have not succeeded.

They have discovered that by combining their spellcasting efforts with those of several wizards and adding the energy of the members, they may be able to break the spell that holds the Falcon. See the chapter, "Ending the Adventure" for more on this.

## Cult Leaders

Following is a description of the cult members that the PCs will eventually meet.

The cult is divided into a hierarchy of four levels. This consists of three leaders, four priests, eight acolytes, and the general membership. While the membership includes wizards, thieves, and warriors, none of these persons has any clerical powers. Members are mainly ordinary citizens of Greyhawk. They live in their own homes and do not come to the cult complex except for meetings and ceremonies. They have limited knowledge of the complex (see the lair description for details).

The leaders share status equally.

None is considered to be of higher rank than the others. Each has talents and shortcomings that are balanced by the others.

The leaders will fight valiantly, but if the situation turns for the worse and they are below 10 hp, they will attempt to escape. They are engaged in serious business by trying to revive the cult, and feel that their survival is imperative.

Priests and Acolytes will fight for the survival of their leaders. Priests and acolytes have been brainwashed to believe themselves to be expendable, but the leaders to be irreplaceable.

In a battle, cult members are likely (75%) to flee. Some will hide or stand confused (15%), but the remaining 10% will join the fight. These members are described in Chapter 2, at the ambush of the PCs. In addition, three mages (levels 9, 7, 6) are members of the cult and will assist the fight but will not fight to the death. They do not consider the cult to be a cause worth dying for.

## Leaders

**Zembak Narsa**, Human Priest, Level 8: AC 2; MV 12; HD 8; hp 54; Str 15, Int 14, Wis 18, Dex 15, Con 13, Cha 16; Dmg 1d8+1; AL CE; THACO 16; age 44.

Equipment: mace, shield, *chainmail +1*, *scimitar +1*, *staff of withering*, *necklace of adaptation*, *potion of flying*, *oil of slipperiness*.

Zembak is level-headed and cautious (for someone who is chaotic evil). He believes in preparation to give himself the best possible advantages. He loves to lure his victims into traps and watch them struggle, although the need for secrecy of the cult has prevented this for a long time. He will take great delight in dealing with the PCs when the time comes. His caution sometimes leads him to indecision, however, and he often has a difficult time with choices (should

we roast the intruders, or let them battle skeletons until they're all dead—hmmmm, tough choice).

Zembak is responsible for contacting Goldie, the jeweler.

Zembak is 5' 10" tall and of average build. He has grey hair that flows halfway down his back. His eyes are grey and calculating. Although only 44 years old, his face is deeply lined with wrinkles, making him appear older than he is. His voice is gravelly and singsong with an almost hypnotic effect.

**Mara Zonin**, Human Priestess, Level 7: AC 1; MV 12; HD 7; hp 48; Str 18, Int 15, Wis 17, Dex 16, Con 11, Cha 9; Dmg 1d8; AL CE; THACO 15; age 36.

Equipment: scimitar, flail, bronze shield bearing unholy symbol of Iuz, *chainmail +1*, *staff of Kitsyrral*, *ring of earth elemental command*, *potion of healing*, *potion of invisibility*.

Mara is intelligent, intense, and has a bad temper (this partially accounts for her low Cha). She believes in dealing the worst possible blow to anyone who commits even a minor infraction (some of the skulls in her room could have testified to this).

However, she is intensely loyal and dedicated to the cause of the cult. She works and studies deep into the night and has seemingly unlimited energy.

Mara harbors a secret hope that as a woman, she will be able to get closer to the Falcon than the men. She plans to make herself available to assist the Falcon in any way possible.

Mara is 5' 6" tall. She is much too thin for her height (90 lbs.), and her face appears tight and drawn in an expression of irritation. She looks frail, but has incredible strength and energy. Her dark brown eyes seem to sparkle with inner energy and excitement, and seem out of place with the rest of her body. Her mousy brown hair



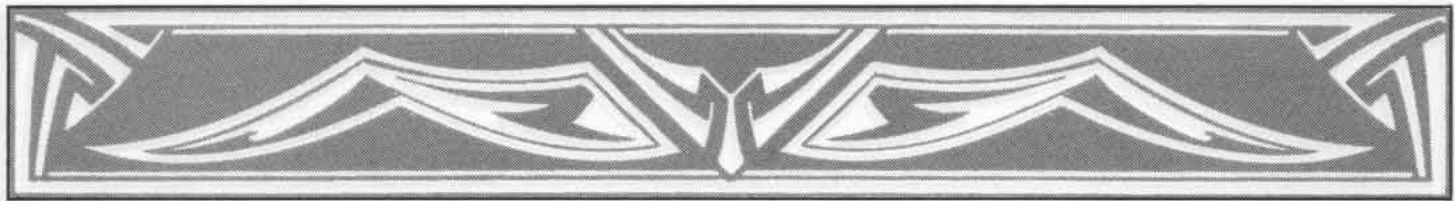

is long and straight, and droops over her shoulders and down her back.

**Embar Dessid**, Human Priest, Level 7: AC 1; MV 12; HD 7; hp 56; Str 16, Int 12, Wis 17, Dex 17, Con 16, Cha 9; Dmg 1d6+2; AL CE; THACO 16; age 33.

Equipment: chainmail, whip, wooden shield, *mace +1*, *dagger +3* (see below), *rod of terror*, *portion of flying*, *incense of meditation* (2).

Embar exemplifies chaotic tendencies. He has a difficult time thinking through decisions, and usually opts for whatever answer strikes his fancy first. He is highly creative and is constantly thinking of ways to build the cult and weaken Greyhawk (although some ideas are farfetched). The combination of Embar's creativity and the decision-making skills of Mara and Zembak make the trio unbelievably dangerous.

Embar's appearance is a dead giveaway to his chaotic nature. He is tall (6' 2") and thin, and looks underfed. His black hair seems to have a mind of its own, and stands nearly straight off his head. (It probably hasn't been combed in years, and Embar takes random chops at it with a scissors when it gets in the way.)

Embar's eyes are a startling shade of bright blue, and he always seems to be grinning about something. Mara and Zembak have grown accustomed to this, but most people find it unnerving.

The *dagger +3* that Embar carries has a hollow blade and a reservoir in the handle. He keeps this filled with class L poison (DMG, p. 73). By means of a tiny lever near the hilt, Embar can release the poison when he chooses. He chose this type of poison over a stronger type because he enjoys battles and likes to see his opponents suffer.

Embar is selective about using his *rod of terror*, but thoroughly

enjoys its effects. He has used it often enough in the presence of the cult that Mara and Zembak are immune to its effects. The remaining cult members are frightened by its effects, but have come to view it as a signal of battle. They are whipped into a frenzy when they view its effects, and rather than running in fear, they become bolstered and their morale increases.

## Priests

All the cult's priests and acolytes are extremely loyal and will die before revealing secrets about the cult. They all live in the underground complex, but this does not prohibit them from wandering freely through Greyhawk. They are cautious, however, not to draw attention to themselves or get into trouble.

**Aldon**, Human Priest, Level 6: AC 2; MV 12; HD 6; hp 38; Str 14, Int 13, Wis 16, Dex 16, Con 12, Cha 8; Dmg 1d6+2; AL CE; THACO 18; age 32.

Equipment: chain mail, shield, *mace +1*, *dagger*, *boots of speed*.

**Bessia**, Human Priestess, Level 5: AC 4; MV 12; HD 5; hp 31; Str 9, Int 15, Wis 17, Dex 12, Con 11, Cha 15; Dmg 1d6+1; AL CE; THACO 18; age 30.

Equipment: chain mail, flail, *ring of protection +1*.

**Dwinnam**, Human Priest, Level 4: AC 6; MV 12; HD 4; hp 28; Str 13, Int 14, Wis 17, Dex 11, Con 12, Cha 16; Dmg 1d6; AL CE; THACO 18; age 30.

Equipment: studded leather armor, club, *ring of fire resistance*.

**Martin**, Human Priest, Level 4: AC 5; MV 12; HD 4; hp 32; Str 16, Int 12, Wis 16, Dex 15, Con 15, Cha 8; Dmg 1d4+1; AL CE; THACO 18; age 29.

Equipment: leather armor, shield, sickle, *ring of feather falling*.

## Acolytes

**Moltar and Fassin**, Human Priests, Level 3 (2): AC 6; MV 12; HD 3; hp 17,15; Str 13, Int 14, Wis 16, Dex 15, Con 12, Cha 11; Dmg 1d6+1; AL CE; THACO ; age 27.

Equipment: studded leather armor, mace.

**Sealin, Parpin, Frallow**, Human Priests, Level 2 (3): AC 7; MV 12; HD 2; hp 14,12,10; Str 13, Int 12, Wis 16, Dex 14, Con 15, Cha 11; Dmg 1d6+1; AL CE; THACO 20; age 25.

Equipment: padded armor and shield, flail.

**Gardin, Korba, Celbar**, Human Priests, Level 1 (3): AC 8; MV 12; HD 1; hp 7,5,4; Str 14, Int 13, Wis 16, Dex 12, Con 11, Cha 10; Dmg 2d4; AL CE; THACO 20; age 22.

Equipment: padded armor, morning star.





## 9: The Falcon Freed

When the PCs have learned enough about the cult, they may embark on the final stage of the adventure. The DM must be certain to read this entire chapter carefully before leading the PCs through the final encounters.

The DM must now decide whether to end the adventure with this module or proceed to the second part of the trilogy, *Falconmaster*. This decision will affect the outcome of this module.

If the party will not proceed with the future adventures, they will be successful in preventing the cult from freeing the Falcon. They will also be able to dissolve most of the cult and turn the matter over to Derider Fanshen of the City Watch.

If the PCs will go on to the future adventures, they will not be able to prevent the cult from freeing the Falcon. They will either arrive too late to stop the ceremony, or will be foiled in their plans. The Falcon will be set free so the PCs can pursue her in the next adventure.

If the adventure is played to its conclusion and the Falcon is not freed, advice is offered at the end of this module for "restarting" the course of events in order to resume the story line. This would allow a DM to continue the trilogy regardless of the outcome of this adventure.

The DM has a great deal of freedom (and responsibility) in concluding this adventure. As an open-ended module, the DM makes the decision as to the success or failure of the PCs. This is *not* a technique to allow the DM absolute power over his players; it is to provide flexibility and control over the module's conclusion. This

does not give the DM the power of life and death over his player characters. The module must still be concluded with a sense of fairness.

Likewise, the DM should not make the adventure so easy or difficult that the players feel cheated. If the players are bombarded with cult members and do not stand even the slightest chance of winning, they may feel that the entire adventure was a waste. Similarly, if the PCs stroll through the lair mowing down every opposition in their path, they will feel cheated out of an exciting and triumphant battle. The DM is advised to use discretion in staging the final scenes.

The DM must first decide, based on his own players, the method by which the PCs come to explore the lair.

1. The PCs may be tipped off by a repentant cult member who is frightened and concerned about the cult's activities. This person may arrive at the Temple of St. Cuthbert, looking for assistance (and possibly sanctuary). The clerics will naturally direct the person to Talasek and the PCs, arranging a meeting between them at the temple.

At the DM's discretion, the cult member may be sincere or may be a trap to lure the PCs into the underground complex where the cult can confront them on their own ground. If the cult member is a trap, he will have had *undetected alignment* cast on him before arriving at the temple.

2. The PCs may find their way into the underground complex through their own devices.

3. The PCs may arrive at the

complex as a ceremony to free the Falcon is underway. This could happen by luck, or it could be due to a tip from a cult member.

The DM must keep in mind that the timing of the PCs' arrival is important. If the PCs arrive as a ceremony is beginning and they lose the battle to prevent the Falcon's release, they will not be able to explore the lair. If they defeat the cult during a ceremony and then explore the underground rooms, this leaves no cult members to oppose them and the exploration will not have the elements of danger and suspense that make exploration exciting and fun. It will merely be a housecleaning of the lair's rooms.

Possibly, the PCs may wish to explore the lair as a ceremony is getting underway. This would place all the cult members in the ceremonial chamber and would reduce the chances of discovery in the lair, but would increase the number of persons opposing the PCs in the battle to stop the ceremony.

### Talasek's Role

Talasek will fight valiantly with his new comrades. He will battle as only a paladin can, with dedication and zeal, committed to the cause regardless of the personal risk. He will also look out for the PCs and defend them as necessary. However, should the battle become too ugly, Talasek will not hesitate to retreat in order to preserve the PCs' safety. He would like to exterminate the cult immediately, but realizes that a second assault is preferable to losing all the PCs and possibly himself, leaving no one to challenge the cult later.





When the decision is made to attack the cult, Talasek will notify the priests at the Temple of St. Cuthbert. This serves several purposes.

First, should Talasek and the PCs be killed, the priests will know what became of them. Then they can do whatever is in their power to carry on the battle against the cult.

Second, the priests can be prepared for wounded. Talasek will naturally escort the PCs to the temple after the battle so their wounds may be tended.

Third, the priests will notify the City Watch of the illegal activities and ask for reinforcements for the party. This is an extremely important factor in the completion of this adventure. The intervention of the City Watch can either save the PCs or cause their demise. The DM will be able to use the City Watch to his advantage to ensure

the desired outcome of the adventure. Since Nestor, the deputy constable, is a cult member, the City Watch will not serve as allies to the PCs; they may turn out to be enemies! More instruction for using the City Watch in the final encounter comes later in this section.

### **Infiltrating the Cult's Lair**

The DM should treat the lair as any other lair inhabited by evil creatures. Remember that these priests are intelligent and cunning, not mindless monsters waiting to be slaughtered. Their goal in life is to free the Falcon so their cult may carry on; if necessary, cult members will retreat in order to preserve enough of the membership to persevere.

However, cult members will fight to the death; only if 80% have

been killed will they flee in order to preserve the cult.

All members will fight to the best of their abilities. The DM should refer to the statistics in Chapter 3 for the cult's thieves, fighters, and mage, and the statistics in Chapter 8 for all priests, acolytes, and leaders. The DM should be prepared to supply statistics for the mages mentioned in these chapters. Remember that all cult members, with the exception of those of adventuring classes, will flee or hide and will not join the fight.

### **Staging the Final Scenes**

As mentioned earlier, the DM should choose the method by which the PCs come to explore the lair. For maximum excitement, the PCs should not explore the under-



ground complex until they are ready to fully assault the cult. Cleaning out the lair will prevent the priests from performing the ceremony to free the Falcon, eliminating the climax of this adventure!

One way or another, the PCs should be allowed to witness at least a portion of the ceremony.

## Dark Rituals

Following is a description of the cult's ceremony to free the Falcon. Notes are provided for the DM so he may correctly advise the PCs of the situation.

The double curtain that divides the ceremonial chamber is always closed at the beginning of a ceremony. The cult's rituals always begin with the robed members entering the ceremonial chamber. They take their seats (not designated seats, although many of the members have their personal preferences and always choose the same bench) and quietly await the beginning of the ceremony. Most of the members meditate during this time.

The first two rows of benches are left empty by the members and are reserved for the priests and acolytes. The leaders never sit during the ceremony; instead, they cluster around the altar. Even if one leader is delivering a speech from the steps, the other two remain at the altar.

When all the members have assembled, the acolytes light the candles in the candlabras throughout the room. The torches along the sides of the room will have been lit before the members began arriving. After the candles have been lit, the priests will arrive and will light the incense in the braziers. This will immediately begin to smolder, giving off clouds of thick, brown, foul-smelling smoke.

The priests will then move to the gongs and drums throughout the room. On a signal from one of the priests, they will first sound the gongs seven times. On the fifth sounding of the gongs, the priests at the drums will begin a quiet, slow drumroll that will gradually grow in intensity and speed. When the drums reach a strong steady level, the curtains will part.

The area behind the curtains will have been filled with smoke through use of a *pyrotechnics* spell. When the curtains part, the smoke will be the only thing visible. But as the smoke begins to billow outward into the main chamber, the cult leaders will step forward out of the smoke. They move slowly, matching their steps, moving in unison. This movement, together with the smoke underfoot, makes the leaders appear to be floating across the floor.

The leaders will come to a stop behind the altar. There, they will begin the ceremony with greetings to this unholy place.

The ceremony proceeds with recitations by the cult leaders telling of the powers and strengths of Iuz. They speak of his evil deeds and desires, and reinforce that these should be the deeds and desires of the cult members.

These words are followed by chants involving the entire membership. Some of the chants are led by the leaders or priests; others are recited in their entirety by all the members. The chanting is accompanied by the great banging and booming of the drums.

The leaders then provide their own examples of evil deeds that please Iuz. Sometimes members are called upon to state any of their most recent evils. Members who state insufficiently heinous deeds are jeered and booed by the crowd.

The heavy, smoky incense has different effects on different peo-

ple, and the effect is not always the same for any one individual. Effects generally do not manifest until a person has inhaled the smoke for at least one turn. The following table summarizes the effects of the incense. Roll for any PCs who may be subject to its effects.

Die roll	Effect
1	Drowsiness
2-3	Giddy feeling as if drunk
4-5	Mild hallucinations
6-7	Severe hallucinations
8-9	Blurred vision and distorted hearing
10	No effect

The effects of the incense will wear off 1d3 hours after the victim leaves the chamber and breathes fresh air.

The ceremony would normally be concluded with a lengthy, powerful chant by the entire membership. Toward the conclusion of this chant, the leaders would retreat to the steps at the front of the chamber. As the chant was concluded, the curtain would be drawn, leaving the leaders behind the curtain. From there, they would retreat through the secret door to their private chambers.

In recent months, however, a new element was introduced into the ceremony. This was the ritual that was designed in an attempt to free the Falcon. Following the normal ceremony proceedings, the leaders and mages would commence this ritual. After unsuccessful attempts, the leaders would make promises of power to the cult members and attempt to bolster faith and morale. Thanks to the incense and the commitment of these members, the propaganda always worked. The ceremonies were then concluded as described above.



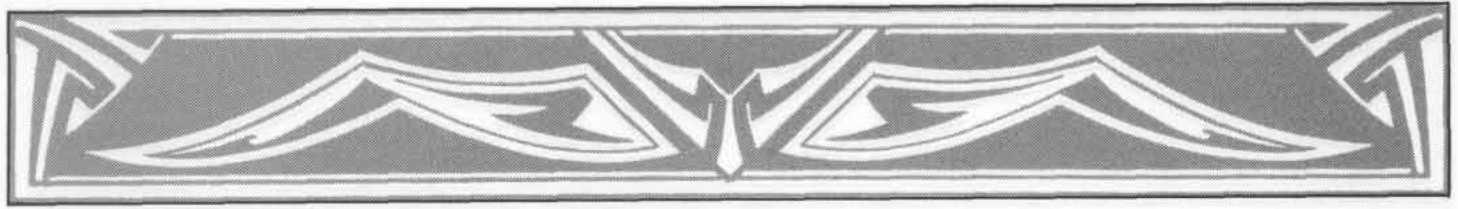

## The Falcon Ritual

The mages and priests have worked and researched long and hard to discover the secret to freeing the Falcon. They have tried a variety of spells from cantrips to *wishes* to no avail. This has cost the cult a great deal of money, since it has no spell casters of sufficient level to cast these spells. The cult was forced to buy these spells as scrolls (when they could be found). A portion of the ritual involves the use of a *wish* scroll. Due to the great cost of these scrolls, the cult has not made many attempts at the ritual. The leaders and mages have worked until they believed the formula for the ritual was absolutely correct before wasting a scroll.

The magic used to trap the Falcon was unique. No records of it were available to the cult members; they were subject to trial and error to discover the solution. The only records of these spells were kept by Mizaab Zalen, one of the members of the original team that trapped the Falcon. This mysterious mage disappeared several years after the cult's demise and he was never heard from again.

The ritual to free the Falcon involves the entire cult membership and all priests, acolytes, and leaders. The mages lead the ceremony, first involving the entire membership in a loud, lengthy chant. The chant is repeated until the ritual is completed.

The priests and acolytes then begin a long series of prayers to Iuz, asking for his assistance in this evil act of freeing his servant. Standing in a tight circle, the mages and cult leaders each begin their own series of specialized spells designed to weaken the barriers of the Falcon's invisible prison.

After the first series of spells, the

highest level mage reads the *wish* spell from the scroll. This is carefully worded and is intended to unlock magical barriers that prohibit the subsequent spells from having any effect.

The leaders and mages then begin a second set of spells. If successful, the conclusion of these spells would set into motion the breakdown of all the magical barriers that hold the Falcon.

When the ritual is successful, wisps of smoke will begin to appear arising from the floor inside the circle of spellcasters. The smoke will gradually thicken and begin to crackle with blue and green streaks of lightning. The spellcasters may move slowly from their positions. Backing away from the smoke is possible, but at a rate of only a few inches per round. Any more activity than this would disrupt the spells.

As the smoke builds and spills into the main chamber, the floor will begin to rumble at the place where the smoke originated. The tiles will begin to crack and pop. This will develop into a hole approximately four feet across.

As the ceremony progresses, the smoke will begin to pour from the hole, changing colors from blood-red to black, to sickly shades of green and brown. The colors continue in a random fashion until the ritual is successful.

The cult members have been successful to this point before, but have never progressed beyond it.

When the ritual is truly a success, all ears in the chamber will hear a long, agonized scream, lasting a full two minutes. As the scream dies away, movement will be detected in the smoke. A thrashing, fifteen-foot, red and black snake with a woman's head will appear out of the smoke. The snake-woman will again scream, but this time the scream will be

that of a person awakening from a nightmare.

The snake-woman will emerge from the hole and break through the circle of spellcasters, writhing and thrashing. After several minutes of this, she will slow her violent thrashing and turn to look at those who freed her. An eerie calm will fall over the chamber, and a new sensation of evil will permeate the room. In a raspy voice, the woman will speak: "This day you have performed a service that you cannot begin to comprehend. You will be rewarded for your perseverance. The reign of the Falcon is once more! Now, take me to a place where I may rest and make my plans."

With that, the curtain will be drawn across the front of the chamber. The cult leaders will remain with the Falcon, ordering the mages and priests to conclude the ceremony and send the members home.

The ceremony may be interrupted at any time. The DM is free to use as many of the visual effects as he sees fit, short of the first scream. If the ceremony is interrupted, all effects will quickly reverse; the smoke will dissipate and the floor will fall back into place.

The ceremony may be stopped if any *one* of the following events takes place:

1. The reading of the *wish* scroll is disrupted.
2. Before the scroll is read, any four of the spellcasters are disrupted and prevented from starting a new spell.
3. After the scroll is read, any three of the spellcasters are disrupted and prevented from starting a new spell.
4. The cult membership is caused to run from the chamber in panic. The noise and vibration of all the cult members fleeing will be

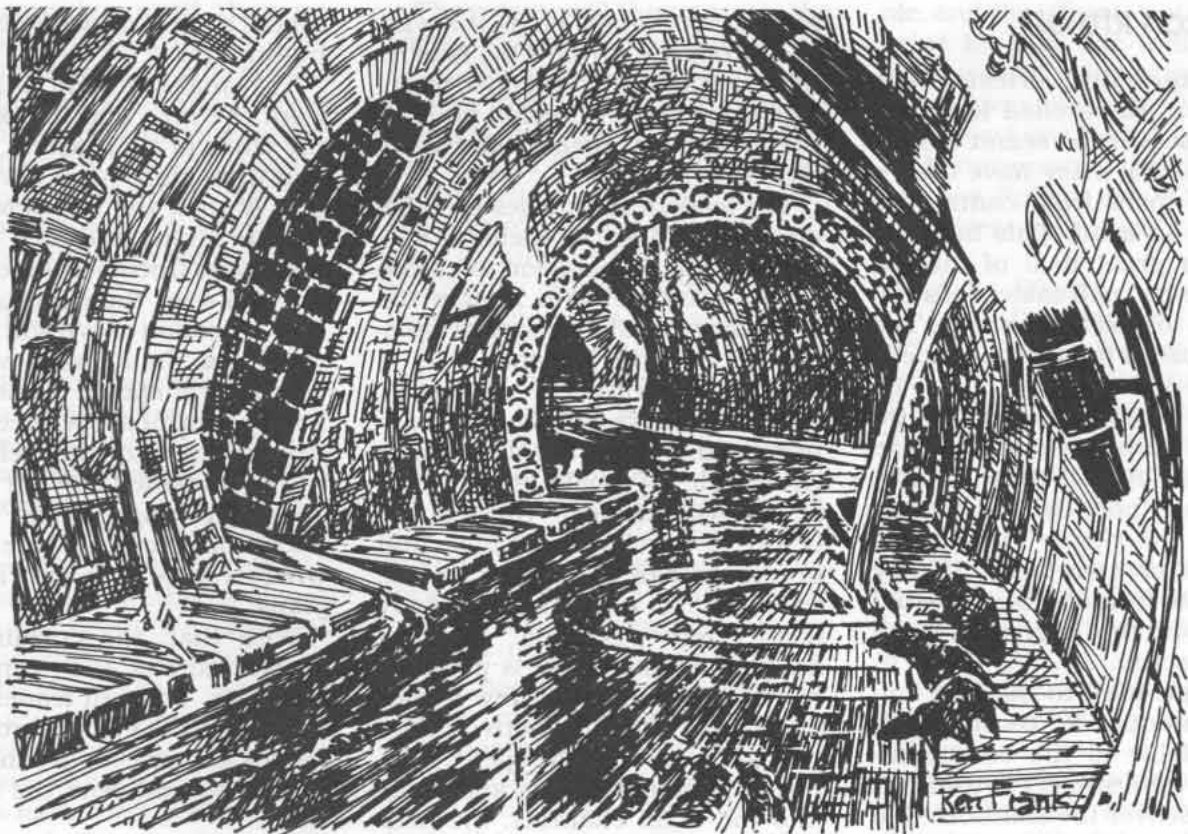

sufficient to drown out the spellcasters and disrupt their spells.

If the DM has chosen to free the Falcon so the PCs may pursue her into the next adventure, the PCs quite possibly may be tied up and held captive in the ceremonial chamber in order to watch the ceremony.

### Intervention of the City Watch

As the Deputy Constable in charge of investigating cult activities in the city, Nestor will naturally be alerted to the reports from the priests of St. Cuthbert of a cult in Old City.

Having been notified of the PCs' intentions to raid the cult lair, Nestor and his cult member guards will be prepared to assault the PCs. They will watch the activities of

the PCs to select one of the following courses of action:

1. If the PCs are losing a battle with the priests, the guards will allow them to lose and will stand aside in order not to reveal their identities.

2. If the PCs are winning a battle or appear to be providing a sufficient threat to stop the ritual, Nestor and his men will step in and break up the fight. This is, naturally, all pre-arranged. He will instruct his men to secure the cult leaders and priests. When this has been done, Nestor will instruct his men to escort the PCs out of the lair, claiming it to be "too dangerous for civilians." Thanking the PCs for their splendid work, he will promise them a substantial reward when the case is completed. Nestor's men will lead them to an exit; once the PCs are gone, they will guard the door.

Nestor will promise that he will

finish cleaning up after the cult. He is actually just removing the PCs so the cult may proceed.

If the PCs defeat the cult, the DM should allow them the run of the lair. They may investigate any sections they desire. The PCs might also receive a handsome reward from Nerof Gasgal, Lord Mayor of Greyhawk, especially if the PCs uncover any of the city officials who are part of the cult.

If the PCs are unable to prevent the release of the Falcon, the DM should use Nestor to clear them out of the lair. The PCs may or may not believe in his efforts to exterminate the cult. This leaves some interesting possibilities for the future adventures.



# Appendix 1: NPCs



This section provides information and statistics about the major NPCs who appear throughout this trilogy. Their intervention and guidance is essential to the advancement of the plot.

## TALASEK THRAYDIN

Human Paladin, Level 6

Str 17  
Int 14  
Wis 15  
Dex 11  
Con 16  
Cha 18  
HP 51  
Alignment: Lawful Good  
Worships: St. Cuthbert  
Armor Class: -3  
Equipment: *Plate armor +3* (an inheritance from his grandfather

and father), great helm, large shield, long sword, lance, morning star (he has weapon specialization in each of these).

Talasek is a tall (6'3"), solid man who takes great care in maintaining his physical condition. He practices and exercises daily, working out with friends and instructing some local youths.

Talasek's wavy brown hair falls just below his shoulders, where it gradually ends in a peak. He has bluish-grey eyes and sharply defined facial features. He never seems to notice the heads that turn his way or the girls who gaze at him dreamily.

Talasek is a third-generation paladin who was raised by his mother after his father was killed in a fire, attempting to rescue several elderly people. Talasek was six years old at the time, and therefore has faded but heroic memories of his father. His childhood was filled with stories of battles, noble deeds, and holy causes.

Talasek was instilled with a desire to live his life as a champion of good and combatant of evil and its vices.

His lineage, however, is a mixed blessing. Talasek is obsessed with proving himself in the manner of his father and grandfather. He will take on almost any cause, and sometimes acts without considering the consequences of his actions. The result is Talasek's greatest weakness; he might easily be duped into misguided activities because, in his eagerness to prove himself, he might accept a mission without fully considering or comprehending it. Talasek is too trusting of others and must learn to be more cautious.

Talasek's good looks and charm

instill instant trust in those he meets. He seems to attract people in need of help, whom he usually escorts to the temple (the priests have convinced him to bring the needy to the temple, since he has a tendency to run out of money by giving it away).

As a trusted servant of St. Cuthbert, Talasek has the same privileges and access to the temple that the priests are allowed. Although not allowed access to areas such as the vault and the private quarters of the temple leaders, he is allowed to come and go as he pleases. He keeps his valuables in the temple's vault, and may request them whenever he chooses.

Talasek lives in a boardinghouse in Clerksburg, near the wall that separates the High Quarter from New City. He is an ideal tenant, but a somewhat disorganized housekeeper. His neighbors in the boardinghouse are all bachelors; some are students, some merchants, some apprentices.

As a paladin, Talasek has few possessions. He buys only what he needs and donates the rest of his money to the Temple or to Nicholi.

The few valuables that Talasek does own are his armor and weapons, a ring that belonged to his mother, and a portrait of his parents. He keeps the ring and portrait in his room, but his armor and weapons are stored in the vault in the temple. The armor, shield, and long sword are family heirlooms; Talasek inherited them from his father and grandfather.

Talasek's shield bears his family crest. The shield is divided into three wedges, each depicting a different goal. Where the three lines that divide the shield come together, a symbol of St. Cuthbert (the starburst) unites them.

The top wedge on the shield depicts a dove perched atop the symbol of the City of Greyhawk. This represents the desire for peace in the city and a life free from evil. The right wedge is an image of the initials of Talasek's grandfather, Talamar Thraydin. The green letters against a white field represent Talamar's desire to raise sons who would fight for the causes of St. Cuthbert. The left wedge is an image of an open book, symbolic of knowledge and history. Talamar had strong beliefs in the power of knowledge and the lessons that could be taught by history.

## FALCON

Spirit Naga  
(Real name: Iysix Ssloll)

Str 16  
Int 14  
Wis 13  
Dex 12  
Con 16  
Cha 7  
HP 63  
Alignment: Chaotic Evil  
Worships: Iuz  
Armor Class: 4  
MV 12; HD 9; #AT 1; Dmg 1-3; SA spell; THACO 11.  
Equipment: Collar of Shapechanging (all other possessions were lost when she was trapped).

A creature of ultimate evil, greed, and vice, the Falcon is exceptionally dangerous due to her cleverness and persistence. Her motivation in life is power, and she will follow any means to gain power or remove those who stand in her way of more power.

As a creature of limited magical abilities, Iysix correctly guessed that she could improve her magic if she could transform into a human. She searched for way to transform herself, and located a mage who was working on a magical shapechanging ring. Iysix stole

the ring and learned that it worked; she could change into a human and use all the spell abilities of a human. (The ring functions under the same rules as the druid's shapechanging ability described on p. 37 of the *DMG*, except that it does *not* bestow the healing property. The mage wasn't finished with the ring when it was stolen.)

Iysix tricked another mage into bestowing the ring with an *enlarge* and a *permanency* spell. This enables her to wear the ring as a collar and benefit from its effects.

Iysix functions as a 9th-level mage when she is in human form. While in any other form, she may only use verbal spells, due to the limitations caused by lack of hands. She may memorize spells while in any form as long as she is able to manipulate her spellbook.

Iysix may appear in almost any form she desires, but her favorites are the forms of a human female and a falcon. When in human form, she always wears a great amount of heavy perfume to mask the foul odor of her naga form.

Falcon's loyalty to Iuz evolved because she viewed Iuz as a means to gain power. At first, her loyalty was insincere, and Falcon worshipped Iuz only for selfish reasons. Gradually, she came to appreciate the forces Iuz was able to command, and she found herself growing in admiration for Iuz and wishing to gain his favor. She began to focus her attention on ways to attract Iuz's attention.

Iuz had long had designs on Greyhawk. It had always been his wish to take over Greyhawk and convert it to a city of evil. When the Falcon learned of this, she devised a plot to take over Greyhawk. In the process, she hoped to become a favorite of Iuz.

In her impatience, she made several mistakes in establishing a cult in Greyhawk. Her cult was destroyed and she was placed in a



magical prison. Surviving cult members made plans to free her and reestablish their position in Greyhawk.

When freed, the Falcon will have one thing in mind: revenge.

## Restarting the Adventure

If the DM has allowed the PCs to defeat the cult and later decides to continue the trilogy, he need only inform the PCs that their victory was not complete. The DM is free to use any explanation he sees fit; possibly members from the nearby cult of Iuz provided assistance, or if the PCs appeared to kill the Falcon or the cult leaders, they may have remained alive or been resurrected. The DM should use whatever device is necessary to rationalize the presence and the threat of the Falcon in Greyhawk.





# Appendix 2: New Magic

## **Bewilder (Enchantment/Charm)**

Range: 60 yards  
Components: V, S, M  
Duration: 1 round/level  
Casting Time: 2  
Area of Effect: Up to 1 creature/  
level in a 40' diam-  
eter area  
Saving Throw: Neg.

A creature affected by this 3rd level wizard spell loses his sense of direction and purpose. When the spell takes effect, the recipient immediately forgets his destination or action and finds himself lost.

Regardless of his intention, a *bewildered* creature forgets whatever he was about to do. This includes swinging at an opponent, casting a spell, following a trail or map, or simply going about daily business.

A spellcaster who is *bewildered* forgets the spell he was about to cast and the spell is lost. He may not cast any spells for the duration of the *bewilderment*, but once the spell has worn off, he may resume spellcasting using any other spells that were committed to memory.

Persons in combat lose their action for the round on which the *bewilder* spell takes effect. On the following round, an Intelligence check is necessary to resume combat. A person in direct combat who passes an Intelligence check realizes that he is in battle and resumes fighting if for no other reason than self-defense, although he may not realize who or why he is fighting.

Affected creatures find themselves lost regardless of their surroundings. They suddenly feel that they have never seen the area before, even in places as familiar as their homeland or even their

own living quarters. They suddenly have no sense of their location or how they arrived there.

A *bewildered* creature is able to recognize his own belongings and comrades, friends, or relatives. He is not any more susceptible to trickery or spells such as *charm*, *suggestion*, or *hold*, or spells of an illusionary nature.

While *bewildered*, a creature will obey the commands of his comrades if a successful Intelligence check is made.

The material component is the eye of any creature and a bit of wool.

## **Priest Lock (Alteration)**

Sphere: Protection  
Range: Touch  
Components: V,S  
Duration: Permanent  
Casting Time: 4  
Area of Effect: One portal up to 12  
square feet/level  
Saving Throw: None

By means of this 2nd level priest spell, a cleric may place a magical protection on any window, door, or portal. The door will open for anyone who speaks the password that was put into place by the cleric who *priest locked* the door.

The password may be a single word or several sentences. The cleric has complete freedom in choosing the password including the language in which it must be spoken. The password will work only if it is spoken in the language that the priest designated. The language does not need to be the native tongue of the spellcaster.

A *priest locked* door or portal may be opened by breaking, or a successful *knock* or *dispel magic* spell, just as a *wizard lock*. The priest may ne-

gate the spell by speaking the password in reverse. This allows the priest to cast a new spell in order to change the password.

When a priest casts this spell, he must designate the duration that the door will be unlocked: The door must physically open during this time or the door will relock and the password must be spoken again.

The priest may also place a time delay on the release of the door. For example, a priest casts a *priest lock* spell on the door to his room. He specifies in the spell that the door will be released two rounds after the password has been spoken and that the door will remain unlocked for five rounds after that. His native language is common, but his password is a phrase spoken in the dwarven language.

The time delay for unlocking a door can not exceed ten rounds. The length of time that the door may remain open is equal to the level of the caster.

## **Staff of Kitsyrral**

XP value: 3500

This staff enables a priest to store spells for later use. The staff can hold 10 charges: each charge is equal to one spell level.

By casting his spells on the staff, the priest imbues it with spell energy. This charges it and later allows the priest to draw upon the stored energy. Any level of spells may be cast on the staff, but the total levels stored will never exceed ten. Excess spell levels are lost.

The priest may cast any spells on the staff. Since they are stored as energy and not as spells, he may later cast any spell from the staff, regardless of whether it was stored originally.

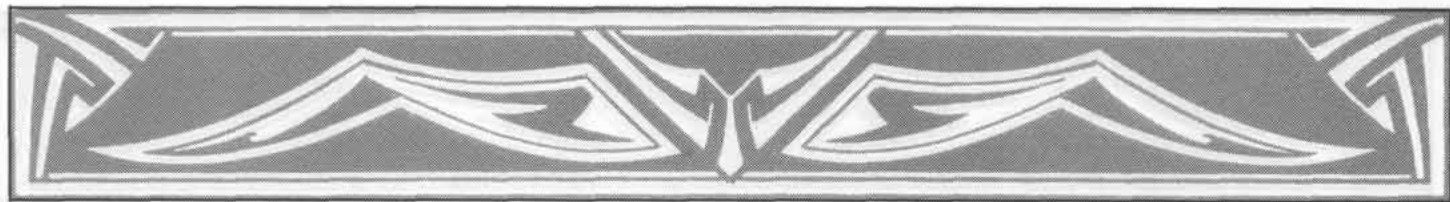

Spell levels may be stored or cast in any combination.

The priest may expend charges at will, using them in any combination (i.e., he may cast any four 2nd- and two 1st-level spells, or ten 1st-level spells, or any combination totalling 10 charges). He may not cast spells that are above his level of spell ability.

Spells cast from the staff take effect in half the time of normal casting, but at the very least have a casting time of 1.

### **Opal of Olfactory Illusion**

XP value: 1000

The Falcon maintains an illusion through magical means, fooling her followers by *polymorphing* herself out of her spirit naga form. However, her ruse would not be complete without masking another of her supernatural characteristics, the stench of rotting flesh that follows her everywhere.

The Falcon uses perfumes to keep her aroma under control and bathes herself daily in exotic oils. But she determined that these were not sufficient. She desired some magical means to cover her nauseating odor. She felt that it would be impractical to hire a wizard to enchant an item specifically for her purposes, since a wizard would likely see through her disguise. She opted to purchase a suitable item plundered from the ruins of the "Mad Archmage's" castle northeast of Greyhawk, discovered by a nefarious thief and offered for sale by his executor.

The Opal of Olfactory Illusion

was simply another of Zagy's experiments, a magical item of limited utility. It forms an orb of 40' diameter around its user. All odors within that sphere are completely under the user's control. He may alter, edit, or ignore any odors within the sphere at will, instantaneously.

The Falcon uses the Opal to edit her surroundings. She removes her own stench from the area, but leaves all other aromas in their places. Of course, when moving, her smell trails behind her. Once her odors pass out of the sphere of effect, they are once again noticeable. This tends to confuse those in her wake, but never leads to her discovery.

The Opal can also be used to create illusory odors that may deter enemies due to nausea. When the Falcon uses the Orb to exude a scent that is repulsive to her victims, creatures who enter the area of its effect must save vs. poison or be incapacitated due to nausea for 1-4 rounds. Those who make their saves successfully suffer no ill effects from the odors.

The Opal itself is an unobtrusive gem of good cut, which, aside from its magical properties, is indistinguishable from other similar stones. The Falcon has it set with several rubies into an anklet she wears constantly.

### **Collar of Change**

XP value: 4000

The collar that the Falcon uses to perform her shapechanging is a rare, possibly unique magical

item. It was created as a ring by an unknown mage and was stolen by the Falcon before its enchantment was completed. Whether the mage created another such ring (the Falcon had the ring *enlarged* to fit her neck) is unknown.

The collar allows the Falcon to change shape three times per day. She may choose any form, whether humanoid, monster, or a form she creates herself. She is able to combine any elements to create new appearances at will, including bizarre creatures such as feathered frogs or giant furry earthworms.

The complete transformation requires one round and the Falcon may not perform any action while the transformation is in progress. Once the transformation is complete, the Falcon receives all the natural abilities of the creature she resembles, but none of the magical abilities. For example, in the form of a dragon, the Falcon would receive the claw and bite attacks of a dragon as well as the abilities for flight, but she would not have the spell abilities or breath weapon of a dragon.

If the Falcon is rendered unconscious or is killed while in an alternate form, she immediately reverts to her natural spirit naga form.

The collar may be used only by members of the wizard and priest classes.



<b>CLIMATE/TERRAIN:</b>	Any
<b>FREQUENCY:</b>	Rare
<b>ORGANIZATION:</b>	Solitary
<b>ACTIVITY CYCLE:</b>	Any
<b>DIET:</b>	Nil
<b>INTELLIGENCE:</b>	Non- (0)
<b>TREASURE:</b>	Nil
<b>ALIGNMENT:</b>	Neutral

<b>NO. APPEARING:</b>	1-6
<b>ARMOR CLASS:</b>	5
<b>MOVEMENT:</b>	12
<b>HIT DICE:</b>	4+8
<b>THACO:</b>	17
<b>NO. OF ATTACKS:</b>	1
<b>DAMAGE/ATTACK:</b>	2-8
<b>SPECIAL ATTACKS:</b>	Strength drain, spittle
<b>SPECIAL DEFENSES:</b>	See below
<b>MAGIC RESISTANCE:</b>	Nil
<b>SIZE:</b>	L (15'-20' long)
<b>MORALE:</b>	Special
<b>XP VALUE:</b>	975

The scryxull can best be described as a zombie snake. They are created by evil clerics and magic users to serve as guardians in vile and loathesome places.

Scryxulls resemble normal snakes, but have been observed in sizes up to 20 feet long. Their most distinguishing characteristic is their skin, which varies in color according to the snake's original appearance. What makes their skin unusual and instantly recognizable is that it appears to be covered by a layer of dust. Closer inspection reveals, however, that this is not dust, but a crusty layer of dead skin.

A scryxull's eyes can also give it away as a zombie snake. Recently created scryxull have solid black eyes, regardless of their original color. They maintain a sheen for up to six months, after which the eyes begin to dry and become dull. Eventually, the eyes drop out altogether.

**Combat:** The scryxull are fierce fighters and always battle to the death. They never retreat. They attack automatically when encountered, but can be called off by a command word from their master.

Scryxull always attack using their bite first. Their length allows them to rise off the ground much like a cobra, allowing them to attack face to face. Many people find this unnerving, and the weak of heart are overcome by fear. Non-adventurers have a 50% chance of succumbing to fear; at 0 level, a 10% chance; at 1st level, a 5% chance; and at 2nd level, a 2% chance.

When the scryxull makes a successful bite attack, it inflicts 2-8 hp and drains 1-3 points of strength.

If the scryxull is wounded or somehow prevented from striking with its bite, it will use its spit weapon. Once every four rounds, the scryxull can spit (THACO 15) an oily glob of dust at its victim, aiming for areas of exposed flesh, especially the face. The spittle acts as a strong topical anesthetic and eventually paralyzes the victim at the following rate:

Round	Effect
1st round	Area of contact feels numb
2nd round	Area begins to stiffen; victim attacks at -4 penalty.
3rd round	Area becomes stiff; if face, arm, or



hand affected, victim drops weapon. Vision and speech impaired if the face was affected; victim attacks at -4 penalty if leg affected.

**4th round** Victim can no longer stand if leg was affected; breathing is labored if face was affected; arm completely numb and useless if affected.

**5th round** No change for arm or leg; victim falls unconscious if face was affected.

Characters are allowed a saving throw vs. paralysis to avoid the effects of the spittle. Armor, clothing, and weapons suffer no ill effects from the spittle. If the spittle is washed off with ordinary water, the effects do not progress beyond that round. If washed off with holy water, the symptoms are removed completely.

If a victim is struck in the torso, follow the effects as if struck in the face. The paralysis will affect the chest muscles, making breathing difficult.

If a victim is a spellcaster, paralysis will limit or prohibit casting. If struck in the face, the spellcaster may not use any spells, but may speak the command word of a magic item on the first round only. If a spellcaster's hand(s) is affected, spells requiring somatic components may not be used after the first round. The DM must rule whether a spellcaster may reach material components, depending on the injury (and whether one hand remains useful).

Scryxull are immune to *sleep*, *charm*, *fear*, *hold*, *death magic*, *poisons*, and *cold-based spells*. Holy water inflicts 2-8 points of damage upon striking. They may be turned by priests as zombies.

**Habitat/Society:** Scryxull may be created anywhere a snake body may be found. The scryxull are typically created as guardians for evil temples, but may also be found in dungeons or the laboratories of evil mages. Scryxull will obey up to six brief commands (attack, halt, be still) spoken by their master.

**Ecology:** None, since the scryxull is created artificially.

<b>CLIMATE/TERRAIN:</b>	Any subterranean
<b>FREQUENCY:</b>	Uncommon
<b>ORGANIZATION:</b>	Swarm
<b>ACTIVITY CYCLE:</b>	Any
<b>DIET:</b>	Omnivore
<b>INTELLIGENCE:</b>	Animal (1)
<b>TREASURE:</b>	Nil
<b>ALIGNMENT:</b>	Nil

<b>NO. APPEARING:</b>	10-80
<b>ARMOR CLASS:</b>	5
<b>MOVEMENT:</b>	1, Fl 9 (D)
<b>HIT DICE:</b>	1
<b>THACO:</b>	19
<b>NO. OF ATTACKS:</b>	1
<b>DAMAGE/ATTACK:</b>	1-6
<b>SPECIAL ATTACKS:</b>	10% cause disease
<b>SPECIAL DEFENSES:</b>	Nil
<b>MAGIC RESISTANCE:</b>	Nil
<b>SIZE:</b>	T (6")
<b>MORALE:</b>	Unreliable
<b>XP VALUE:</b>	65

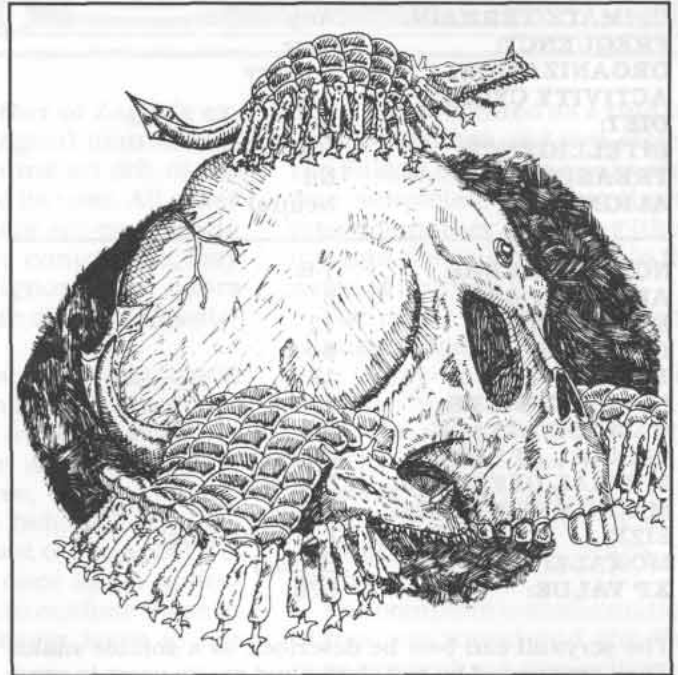

Grythok range in size from 2" to 6" long. Their soft bodies are oval-shaped and covered by a tough, leathery shell. All organs and exposed areas are completely covered by the hemispherical shell.

Beneath the shell are the grythok's mouth, legs, and sensory organs. The mouth is circular and completely surrounded by sharp teeth. The 12 legs are short and sharp, barely functional for movement, but effective for digging in and holding on to any material softer than leather. These legs have adapted to allow the grythok to hold on to its food or prey in order for the mouth to successfully attach. The legs function as barbs and cause no damage if the grythok releases them willingly, as when it is finished with a food source and chooses to move on. However, the legs cause 1-4 hp if the grythok is forcefully removed from its victim.

**Combat:** These creatures generally cling to the walls, floor, and ceiling of underground caverns. When a creature approaches, the grythok is aroused by any aura other than evil that comes within 60'. It immediately takes flight and attacks with all the vigor of an animal in a feeding frenzy. As it does so, it emits a high-pitched shriek that is inaudible to humanoid ears but is a clarion call to other grythok. Its cousins will respond to this "dinner bell" immediately, arriving at a rate of two per round. The shriek is audible to other grythok only within 60', but as farther grythok respond, they emit their own shrieks and the call carries through tunnels and caverns in a ripple effect.

The grythok is able to smell flesh, whether warm or cold, and attempts to attach itself to any exposed flesh. It immediately digs in with its barbed legs and then attempts to sink its bite into its victim. A successful "to hit" roll by a grythok means that both its legs and mouth have dug into its victim's flesh. It will remain attached until it has finished feeding or has been forcefully dislodged.

The grythok then begins to take circular bites out of its victim, and slowly moves itself along to fresh areas of skin. Its many legs allow it to reposition itself without

releasing its iron grip. A single grythok will inflict a maximum of 30 hp before it is "full" and drops off its victim. If anyone makes successful THACO and Dexterity rolls, the grythok is dislodged at a cost of 1-4 hp to the victim.

One in ten grythok carry a disease due to their scavenging habits. This is not a result of a spell, but simply due to the filthy conditions in which they live. No saving throw is applicable.

Grythok may be destroyed by any normal means, but attacking a grythok attached to a character also presents a risk of injuring the victim. A successful attack on an attached grythok indicates equal damage to the victim; a miss on an attached grythok requires a "to hit" roll against the victim.

**Habitat/Society:** The grythok are underground scavengers that inhabit dark, musty, dirty places. They are found mainly in sewers, garbage dumps, latrines, and cesspools, but rarely anywhere else, since they require conditions of filth to survive. They will eat almost anything, but prefer meat and meat-like substances, including rodents, insects, worms, and snakes. They would make ideal garbage disposals if it were not for their vicious and frequent attacks.

**Ecology:** Lengthy evolution has rendered these creatures immune to most diseases, although they are carriers and transmitters of many forms of plague and disease. They reproduce via egg-laying twice per year, but their population growth rate is slow since they often accidentally devour their own eggs.



<b>CLIMATE/TERRAIN:</b>	Any
<b>FREQUENCY:</b>	Very rare
<b>ORGANIZATION:</b>	Solitary
<b>ACTIVITY CYCLE:</b>	Any
<b>DIET:</b>	Carnivore
<b>INTELLIGENCE:</b>	Semi (3)
<b>TREASURE:</b>	Nil
<b>ALIGNMENT:</b>	Chaotic Evil

<b>NO. APPEARING:</b>	1-20
<b>ARMOR CLASS:</b>	5
<b>MOVEMENT:</b>	15
<b>HIT DICE:</b>	3
<b>THACO:</b>	17
<b>NO. OF ATTACKS:</b>	1
<b>DAMAGE/ATTACK:</b>	1-3
<b>SPECIAL ATTACKS:</b>	Class B Poison
<b>SPECIAL DEFENSES:</b>	See below
<b>MAGIC RESISTANCE:</b>	Nil
<b>SIZE:</b>	S (4-6' long)
<b>MORALE:</b>	Average (8)
<b>XP VALUE:</b>	175

Carpet snakes are a most unusual and frightening monster. They can be especially deadly due to their poison and method of attack. Victims can find themselves completely surrounded by these snakes before realizing they are under attack.

These serpents spend most of their lives in a dormant state. They are able to change their physical composition in order to blend with a rug or carpet. In this state, they can exist up to one year without feeding. They are completely dormant and do not eat, sleep, or breathe. Any food that has been ingested is absorbed slowly, sustaining them over a long period. A small rat can sustain a carpet snake up to six months.

Carpet snakes become active on command of a master or when sensing the presence of prey. They can be taught to recognize up to five masters and four simple commands. They will never attack their masters, and will generally attack anything that moves unless halted by a master's command.

**Combat:** When a carpet snake senses motion or vibrations caused by any creature walking on its carpet, it begins to take shape in 2-4 rounds. It can sense the presence of a master and will not form unless commanded to do so. The carpet will first appear to writhe on the second round after the carpet was initially walked upon. At first, victims may guess this to be an hallucination or illusion, but as the snakes begin to take shape, they will realize the danger at hand (at foot, actually).

The snakes require two rounds to fully form. During this stage, they are treated as AC 10.

If an opponent is small enough for a carpet snake to swallow, it generally fights to the death in hopes of a meal. With larger opponents, carpet snakes return to carpet-form if reduced to 3 hp.

A carpet snake may return to carpet-form in one round. It cannot be wounded in this form. Even if the carpet is slashed, the snake may reform. If the carpet is cut and the pieces are carried more than 20 yards apart, or the carpet is burned, the snakes cannot form.



If an attempt is made to sever a snake into two pieces, the attempt is not successful unless the blow inflicts damage equal or greater than half the snake's total hit points. In such a case, the carpet snake would immediately revert to carpet form and may reform in 24 hours.

Carpet snakes that are reduced to 0 hp are killed. Those that revert to carpet form to escape cannot reform until 24 hours have elapsed.

**Habitat/Society:** Carpet snakes were originally created by magical means, but are able to reproduce as normal snakes. When a clutch of eggs is laid, the female snake generally remains in snake form to guard them. Most breeding takes place in controlled environments, such as a nursery established by an evil being. When carpet snakes breed spontaneously, their masters generally move the female and her eggs to protected quarters.

Carpet snakes will live in any rug or carpet, or, if nothing suitable is available, may live in clothing or other fabric. They appear to be woven directly into the article, and close examination reveals nothing of their true nature.

If a master is present, carpet snakes will allow themselves to be rolled up or folded in a rug without taking shape. The rug and snakes can be transported in this manner. If a master orders an attack in this state, the snakes form normally but require 1-2 rounds to crawl from the rug.

**Ecology:** Carpet snakes are always red in color with black eyes. In carpet form, they may be coiled, twisted, or straight. They appear to be simply part of the fabric, and maintain whatever shape they held when they converted to carpet form.

If a carpet snake is killed, it collapses into a pile of fibrous red dust. The dust may not reform and is useless.

Carpet snakes have a lifespan of up to 50 years.



## Appendix 4: Rumors

The following rumors are indicated as to their truth or verification. If no indication is given, the rumor is only a rumor—no evidence can be found to support it.

1. The City of Greyhawk has strict laws forbidding the existence of evil cults in the city. Cults that are discovered are dealt with swiftly and mercilessly; leaders are put to death and followers are banished from the city forever. (Easily confirmed as true.)

2. A vampire has been reported stalking the streets of Old City.

3. The temple of an evil cult was once housed in a warehouse in the burned section of Old City. The fire was the result of the attack on the cult. (Can be confirmed as true.)

4. Strange animal howlings have been heard coming from Shacktown late at night.

5. The students of the University of Magical Arts are fond of testing their powers on unsuspecting citizens, making them the victims of numerous practical jokes. (This practice is strictly forbidden by the University; students caught in such activities are expelled.)

6. The Sacred Temple of St. Cuthbert is constructed in such a way as to concentrate the powers of its clerics.

7. The Sacred Temple of St. Cuthbert cannot be infiltrated. Those who have tried have found scores of clerics waiting for them as they attempted to enter the premises. (Can be confirmed as true.)

8. The residents of Old City have observed an unusually high number of unfriendly strangers roaming the streets in the past few months. (Can be confirmed as true.)

9. During the last new moon, the ruins of the burned section of Old City shivered and shuddered suddenly in the middle of the night. A great cloud of ash and dust rose from the debris, but no other section of the city was affected by this shaking. (Can be confirmed as true.)

10. *Note: Do not reveal this rumor unless specified in the text.* At least ten residents of Shacktown, mostly men, have disappeared in the last few months. (Can be confirmed as true by speaking with Nicolai Nortoi at the shrine of St. Cuthbert in Shacktown.)

11. Once every 13 years, the Selintan River turns blood red under the first full moon of autumn. The last incident was 12 years ago.

12. Members of the City Watch have been scared away from their posts at the exterior gates in the wee hours of the morning.

13. Strange monkey-like creatures have been seen cavorting on the opposite shore of the river under the full moon.

14. The city treasury has been broken into recently but nothing was taken.

15. The burned-out section of the Old City has always been spooky, but residents of that area have been whispering lately that it is haunted. Women and children are afraid to walk past the ruins after dark.

16. Dockworkers have threatened to strike due to lack of protection from some dangerous cargo that has arrived recently.

17. The northern hills are home to a race of magical creatures who steal children and teach them magical spells.

18. Farm animals have been disappearing mysteriously from the farms surrounding the city.

19. If a person stands in the center of the Stone Ring outside the Druid's Gate, he can think, speak, and act without being observed by *any* magical means. (The PCs can test this themselves; it is true!)

20. The city is home to at least one magical dragon that masquerades as a human. (Everyone believes this rumor but no one has been able to prove it.)





	Waterpipe
	Cistern
	Burial Site
	Secret Passage
	Secret Door
	Sewer
	Sewer Opening to Surface

- ### The City of Greyhawk
1. Shacktown
  2. Wharf Gate
- ### high quarter
3. Grand Citadel
  4. High market
  5. Sacred Temple of St. Cuthbert
  6. Cargo Gate
  7. Garden Gate
  8. Duke's Gate
- ### new city
9. Lalasek's Boardinghouse
  10. low market
  11. The Whistling fish
  12. Marsh Gate
  13. Druid's Gate
  14. Stone Ring
- ### Old City
15. Black Gate
  16. The Great Burn
  17. fish processing Warehouse
  18. Mill/Grain Warehouse
  19. produce Warehouse
  20. Highway Gate
  21. The processional





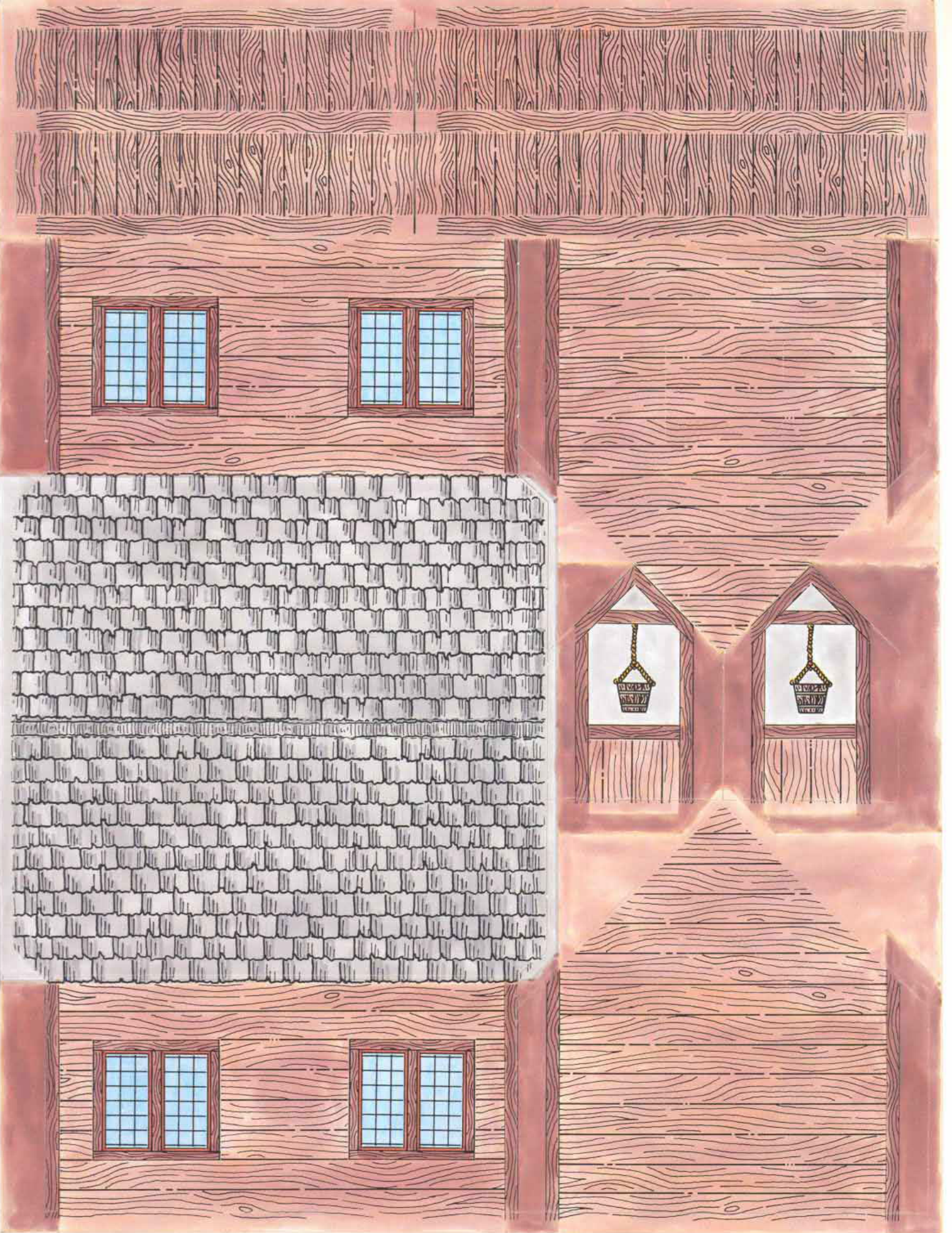

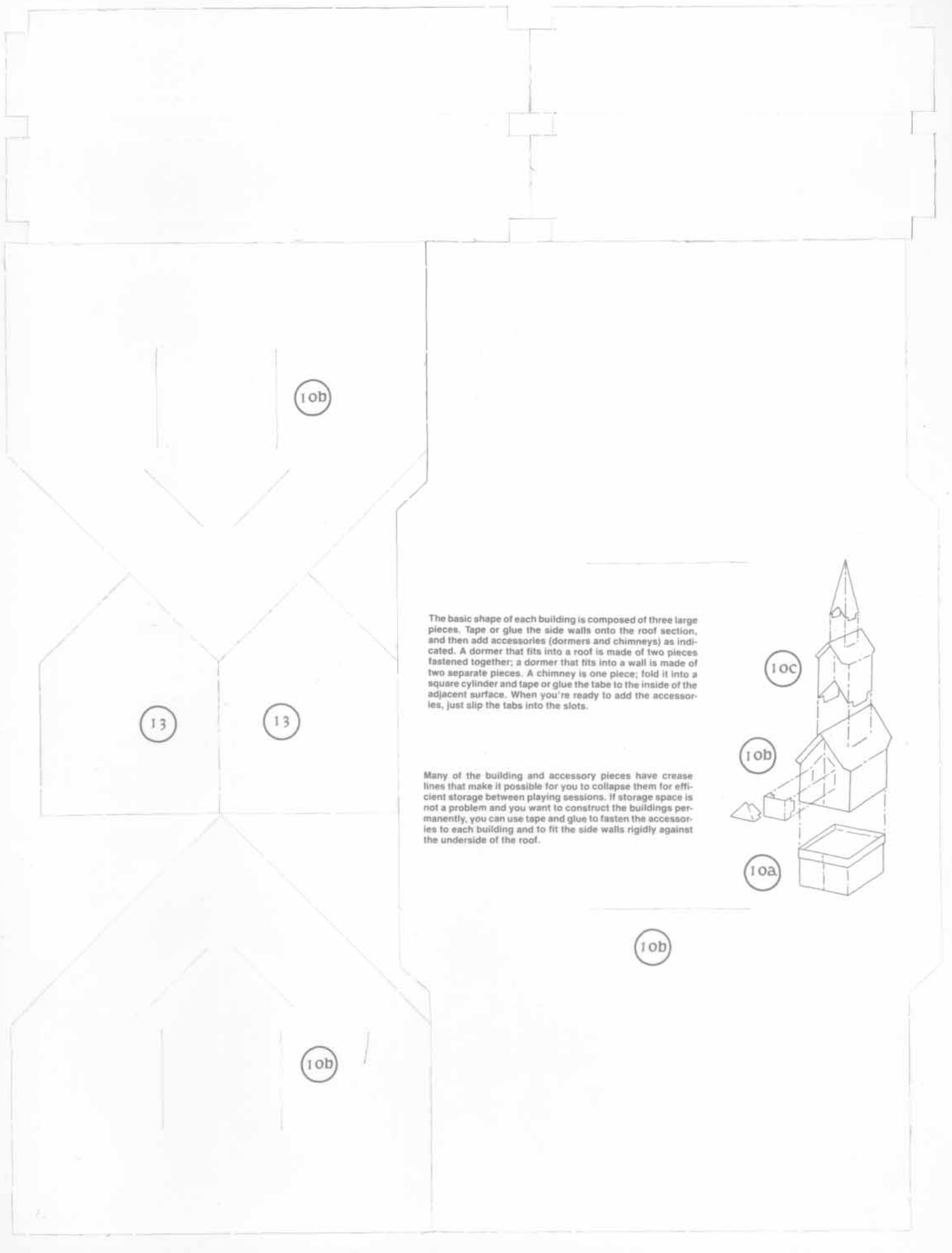

10b

13

13

10b

The basic shape of each building is composed of three large pieces. Tape or glue the side walls onto the roof section, and then add accessories (dormers and chimneys) as indicated. A dormer that fits into a roof is made of two pieces fastened together; a dormer that fits into a wall is made of two separate pieces. A chimney is one piece; fold it into a square cylinder and tape or glue the tabs to the inside of the adjacent surface. When you're ready to add the accessories, just slip the tabs into the slots.

Many of the building and accessory pieces have crease lines that make it possible for you to collapse them for efficient storage between playing sessions. If storage space is not a problem and you want to construct the buildings permanently, you can use tape and glue to fasten the accessories to each building and to fit the side walls rigidly against the underside of the roof.

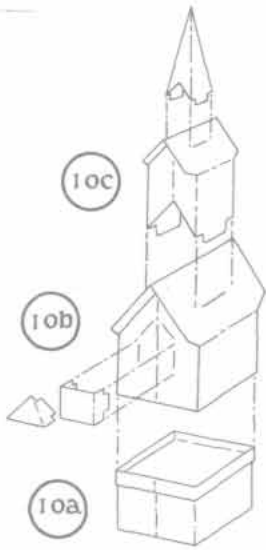

10c

10b

10a

10b



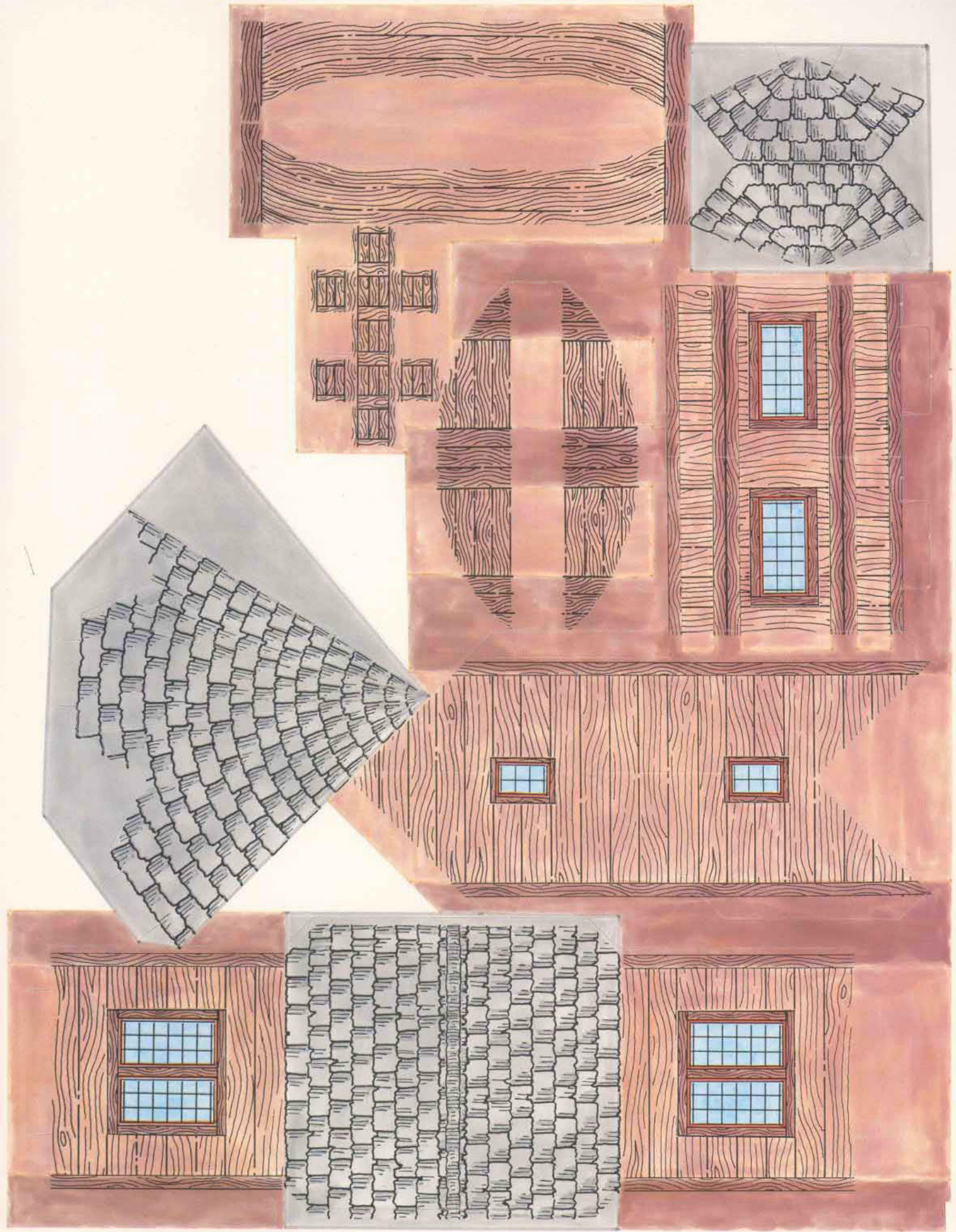

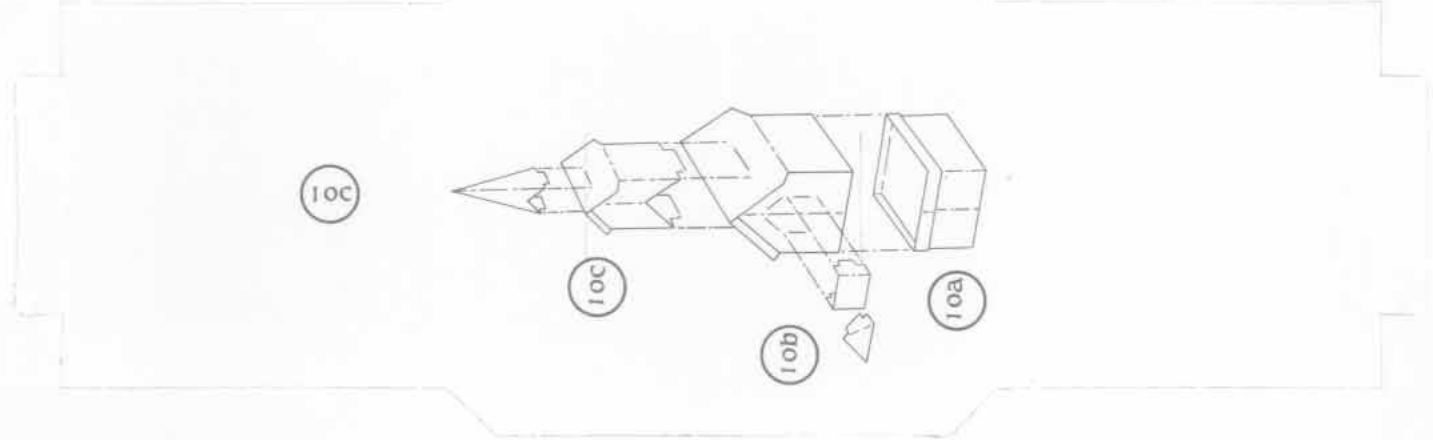
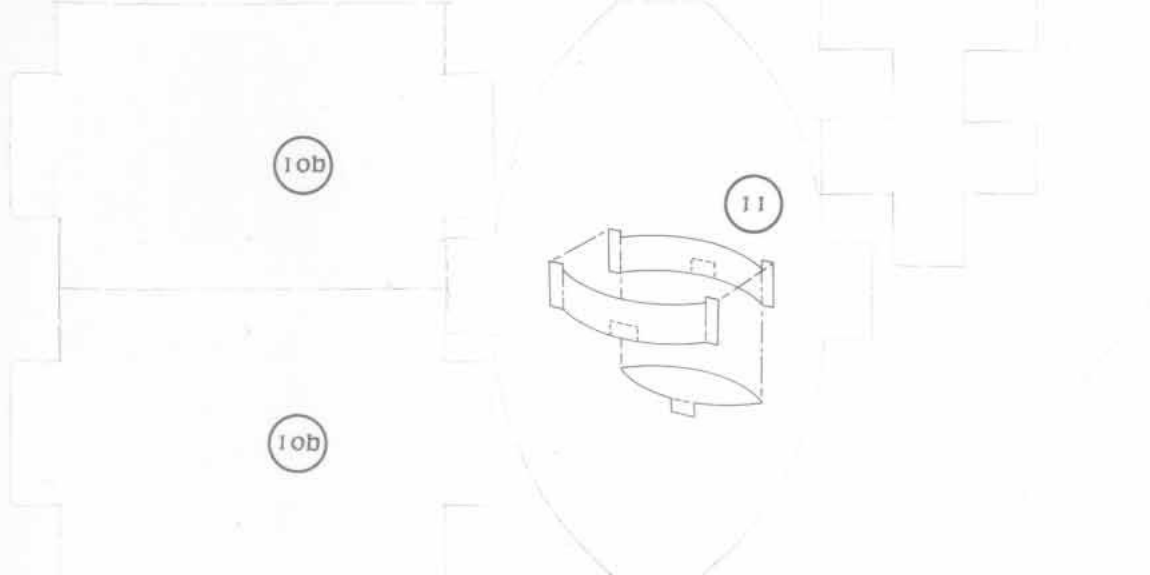
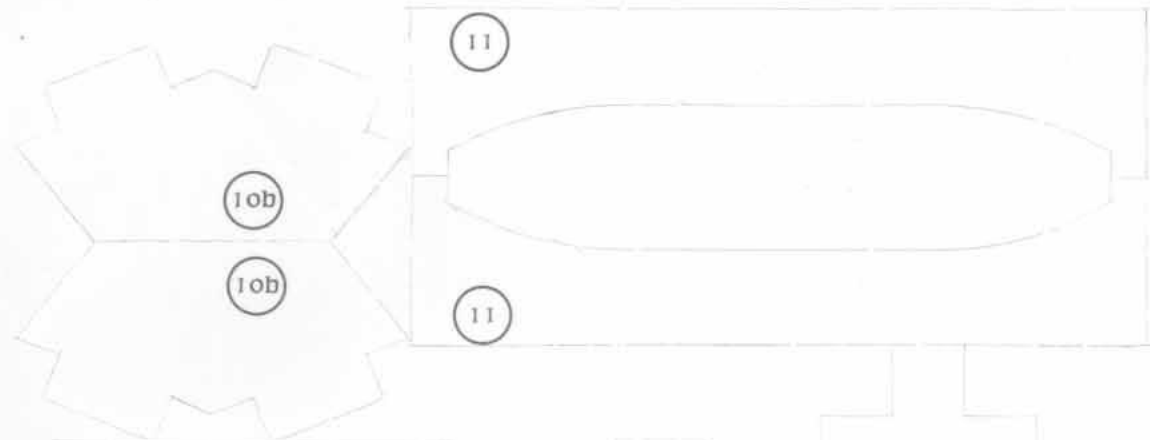



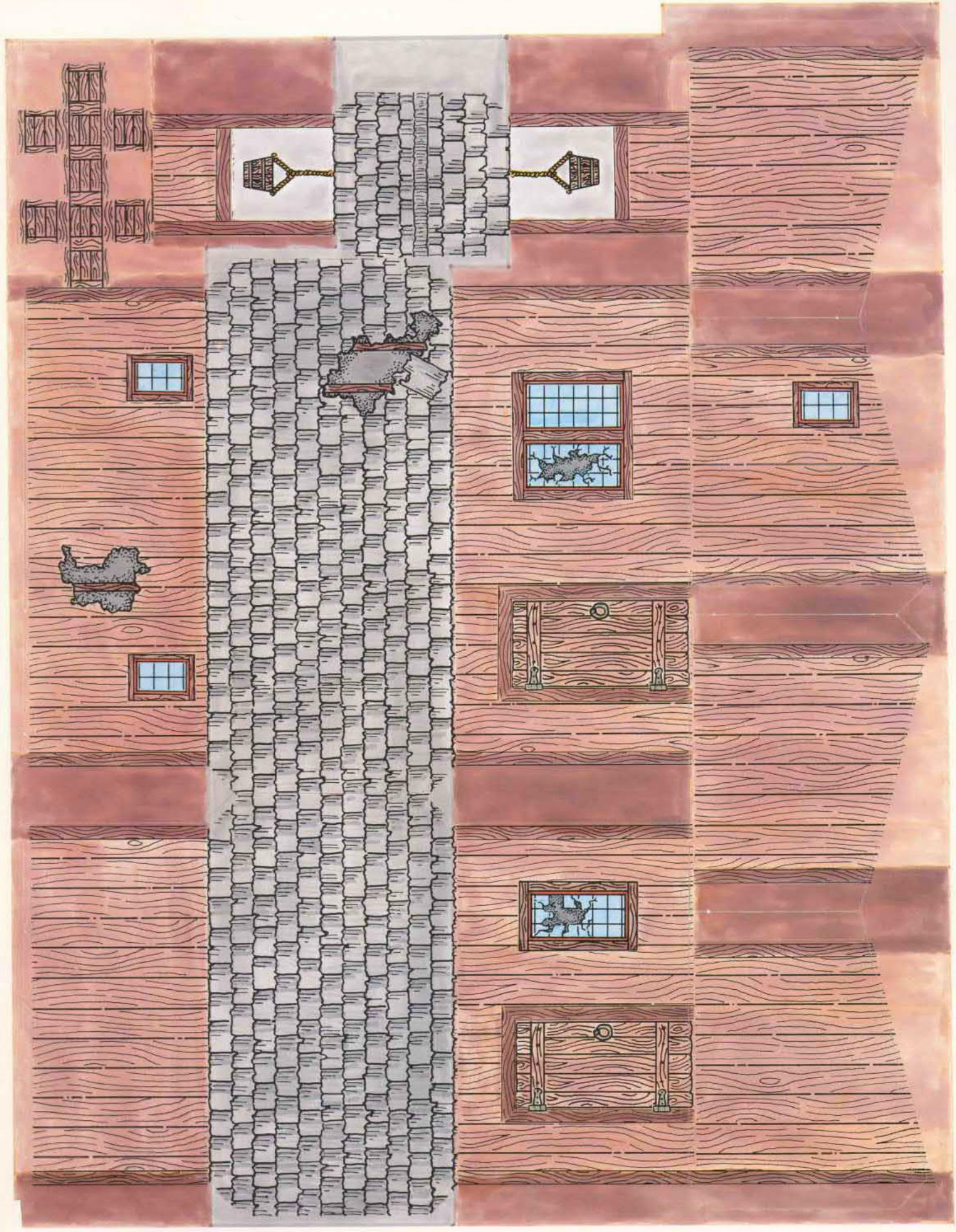

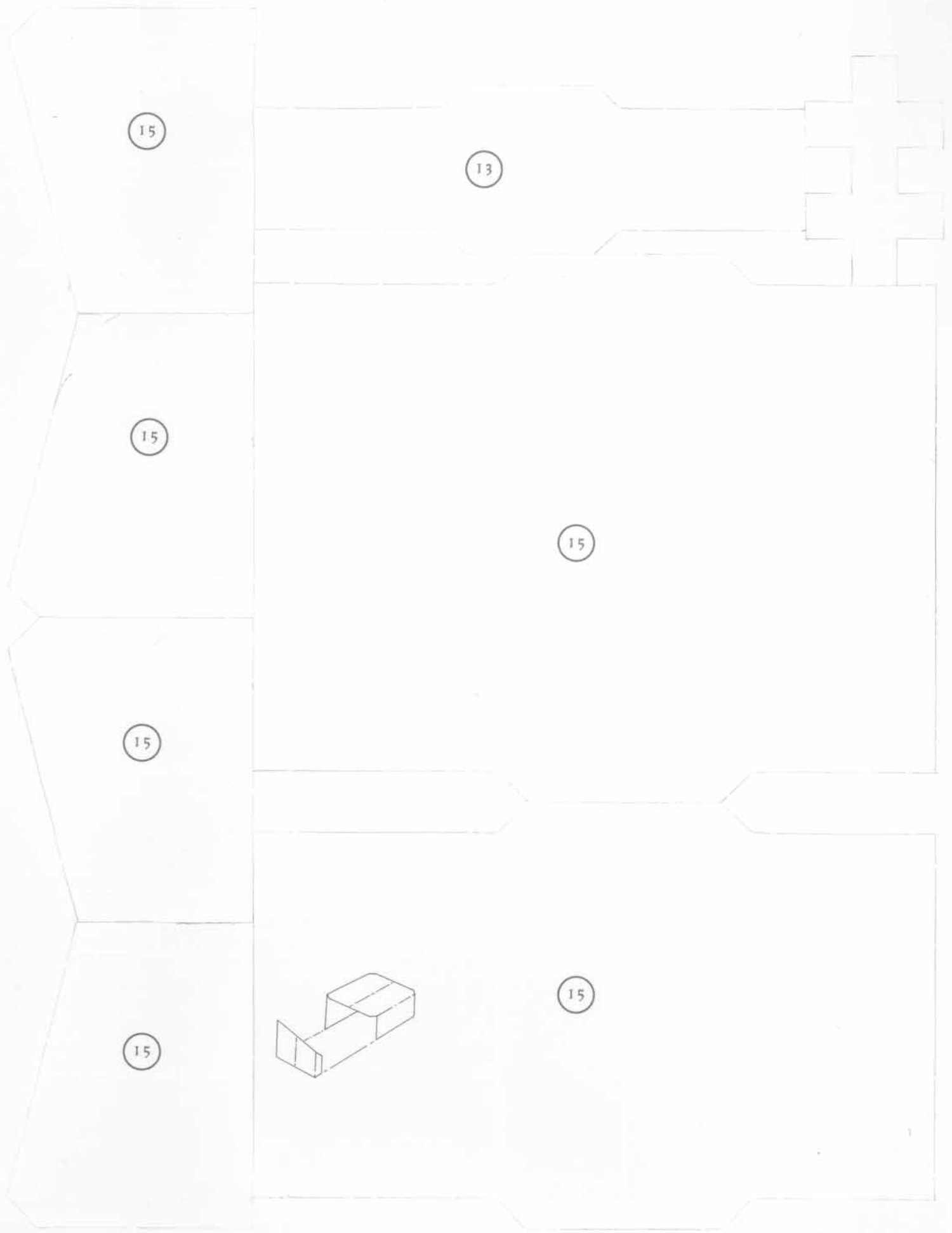

15

13

15

15

15

15

15

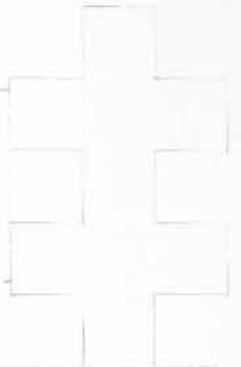
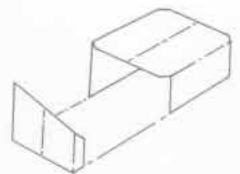



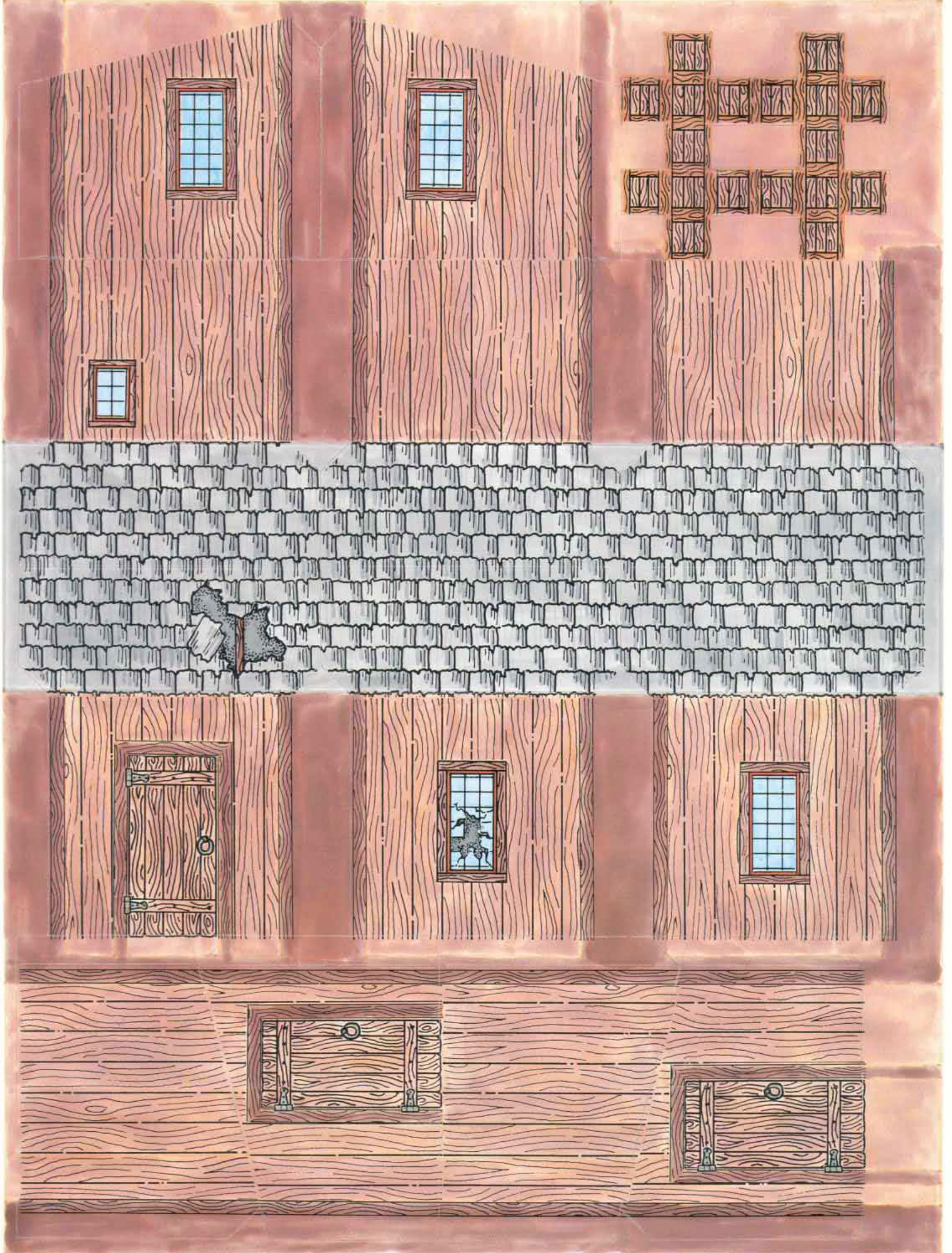

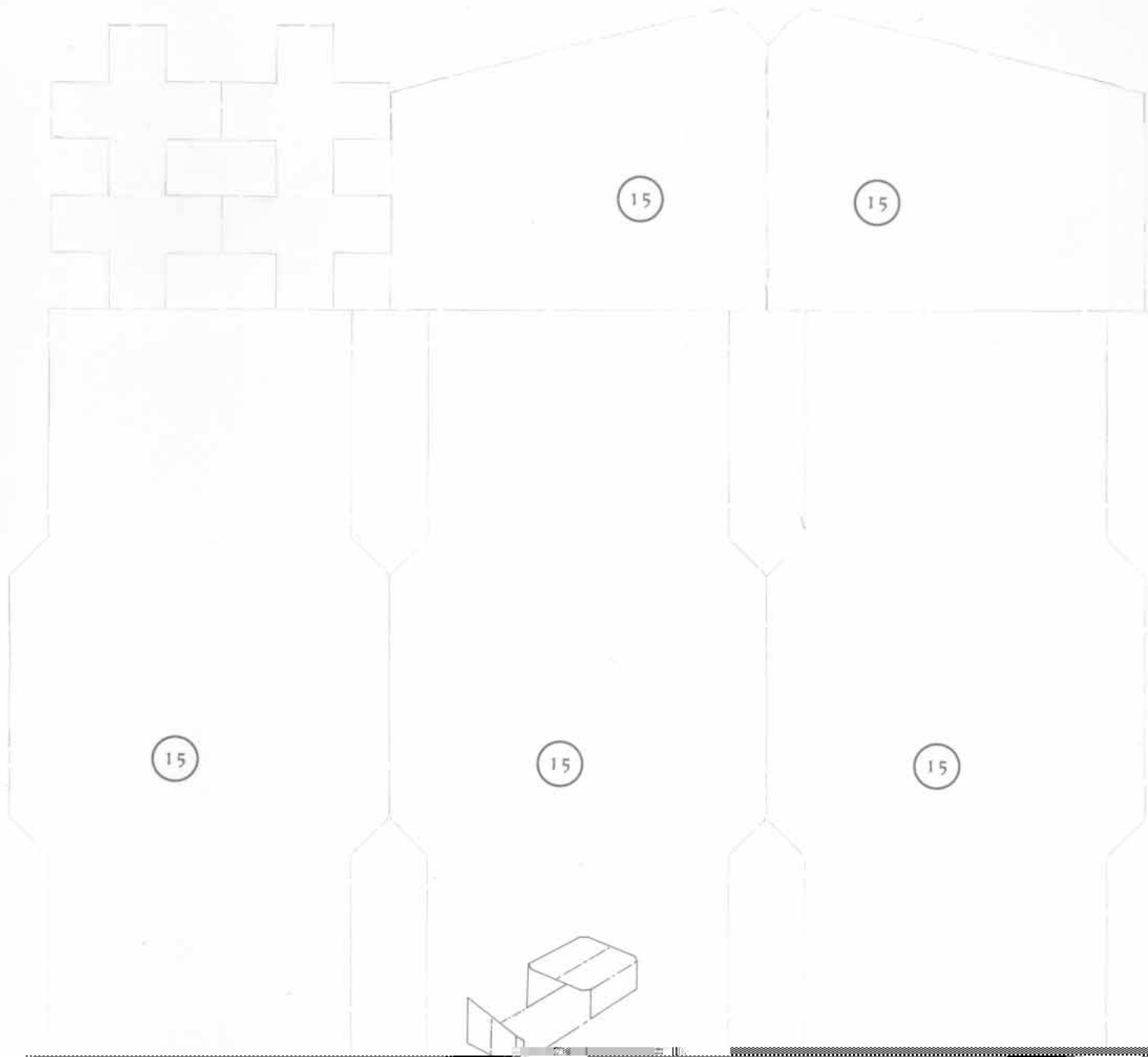

15

15

15

15

15

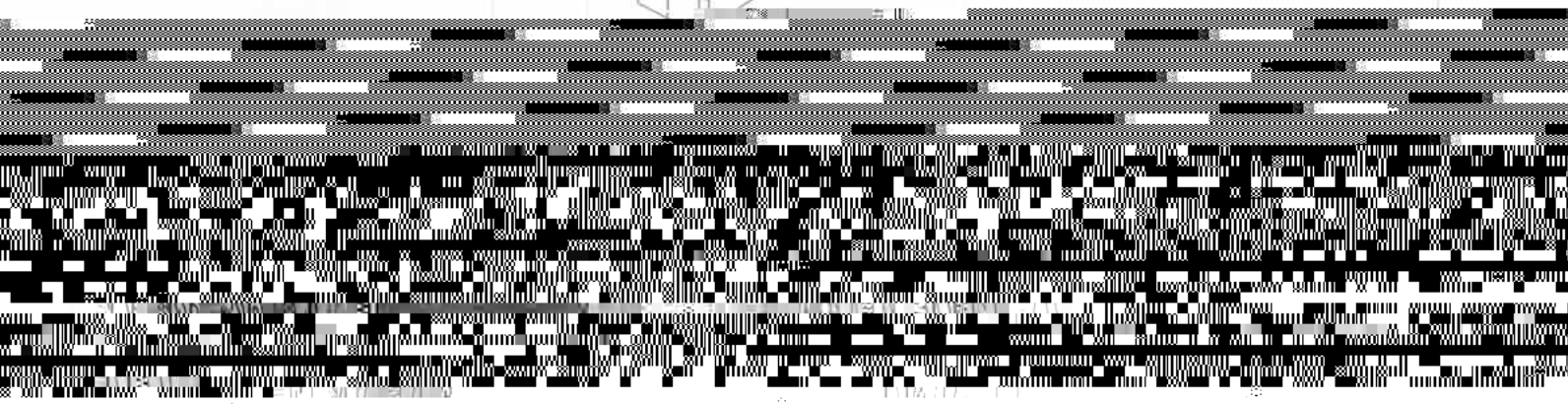



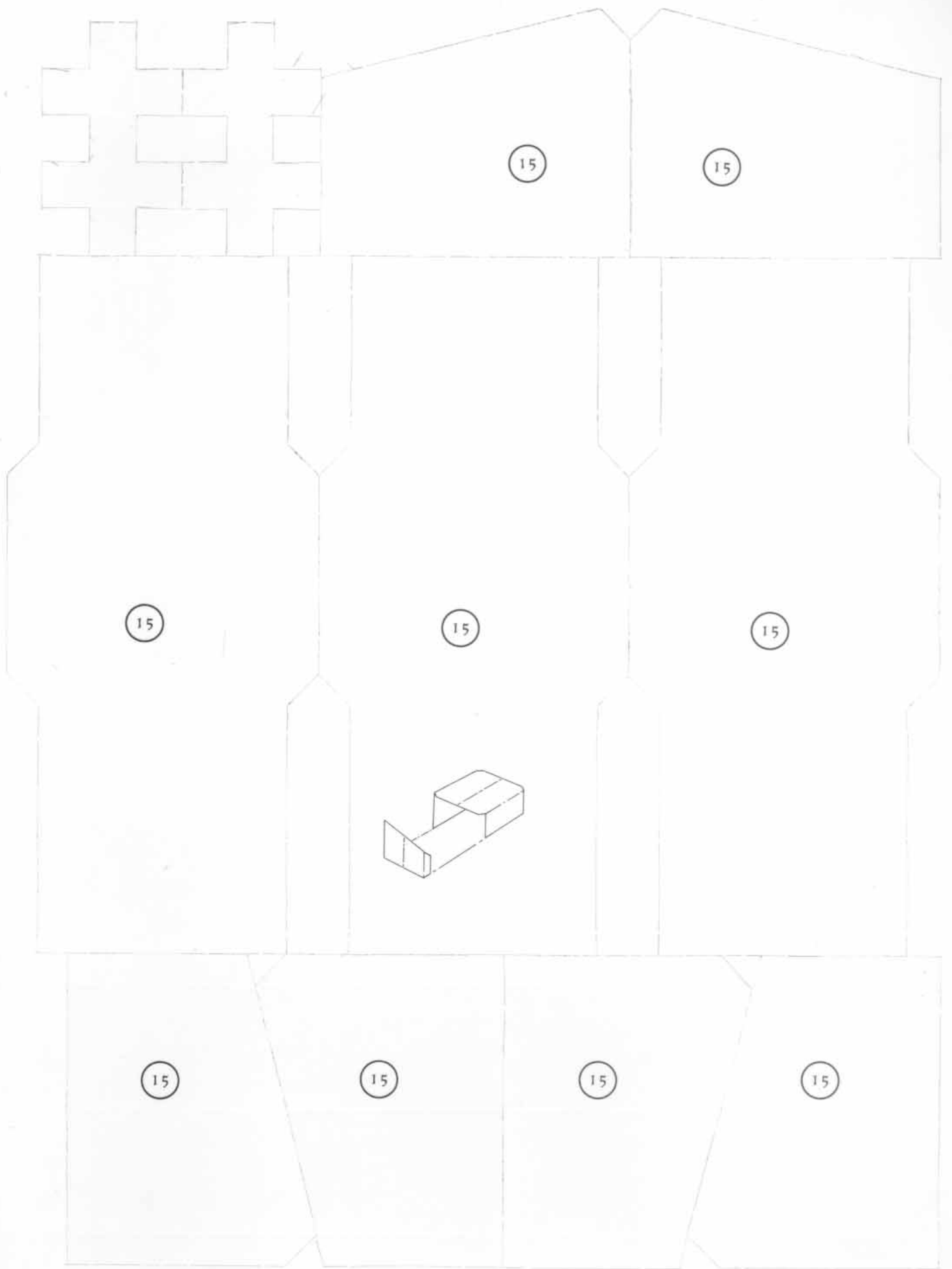

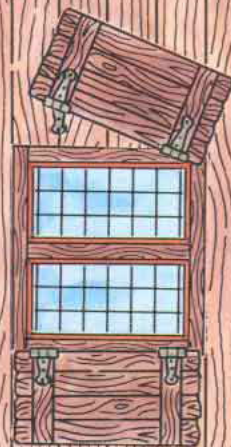
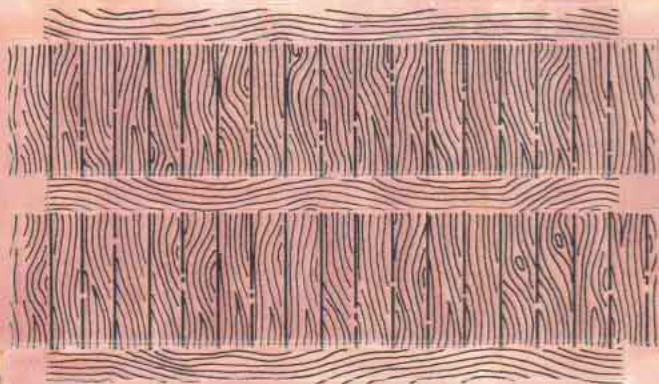
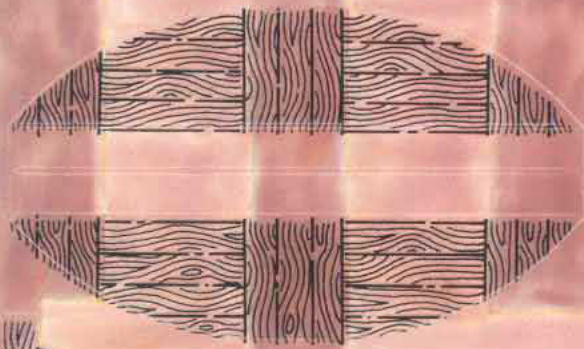



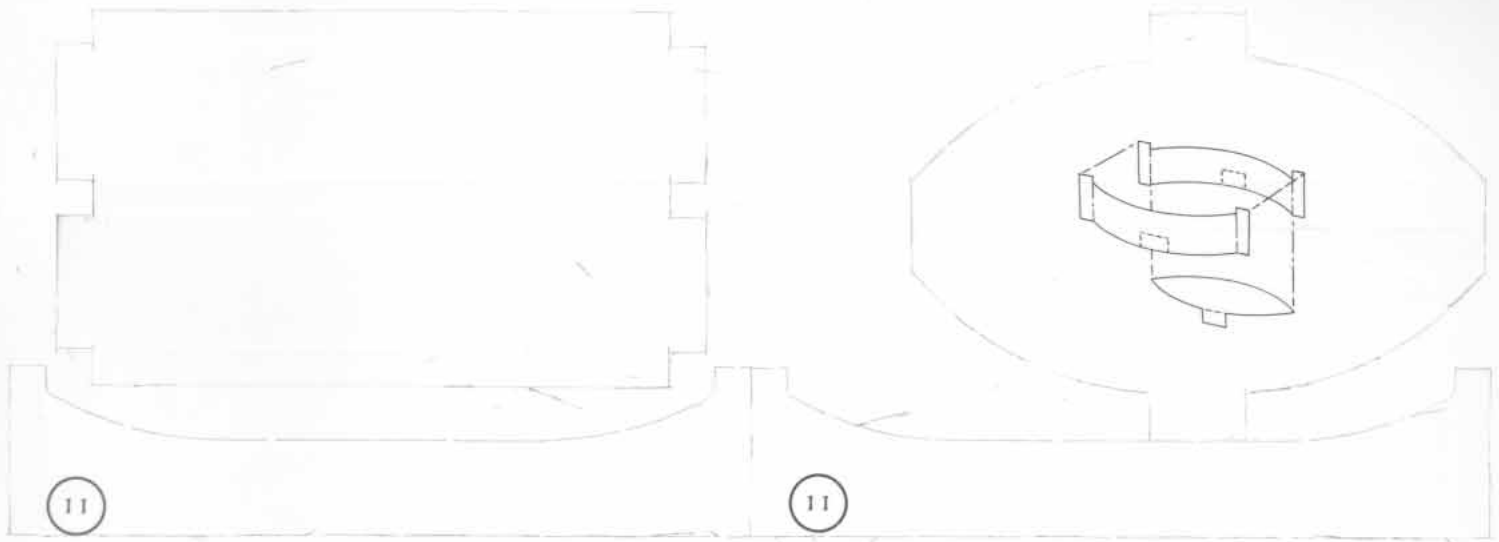

10a

10a

10a

10a

10a

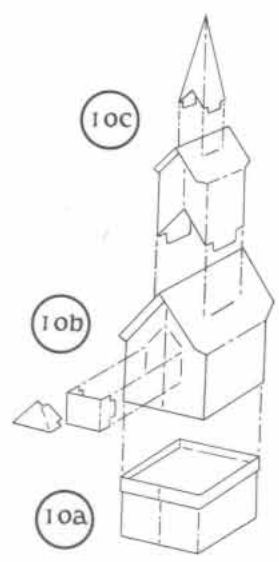

Each flat-roofed building is a box made of three pieces. When the box is finished, add the two pieces that form a collar around the top. To make a tall structure, fit another completed building inside the collar and down onto the roof (which now becomes the floor of the upper story).

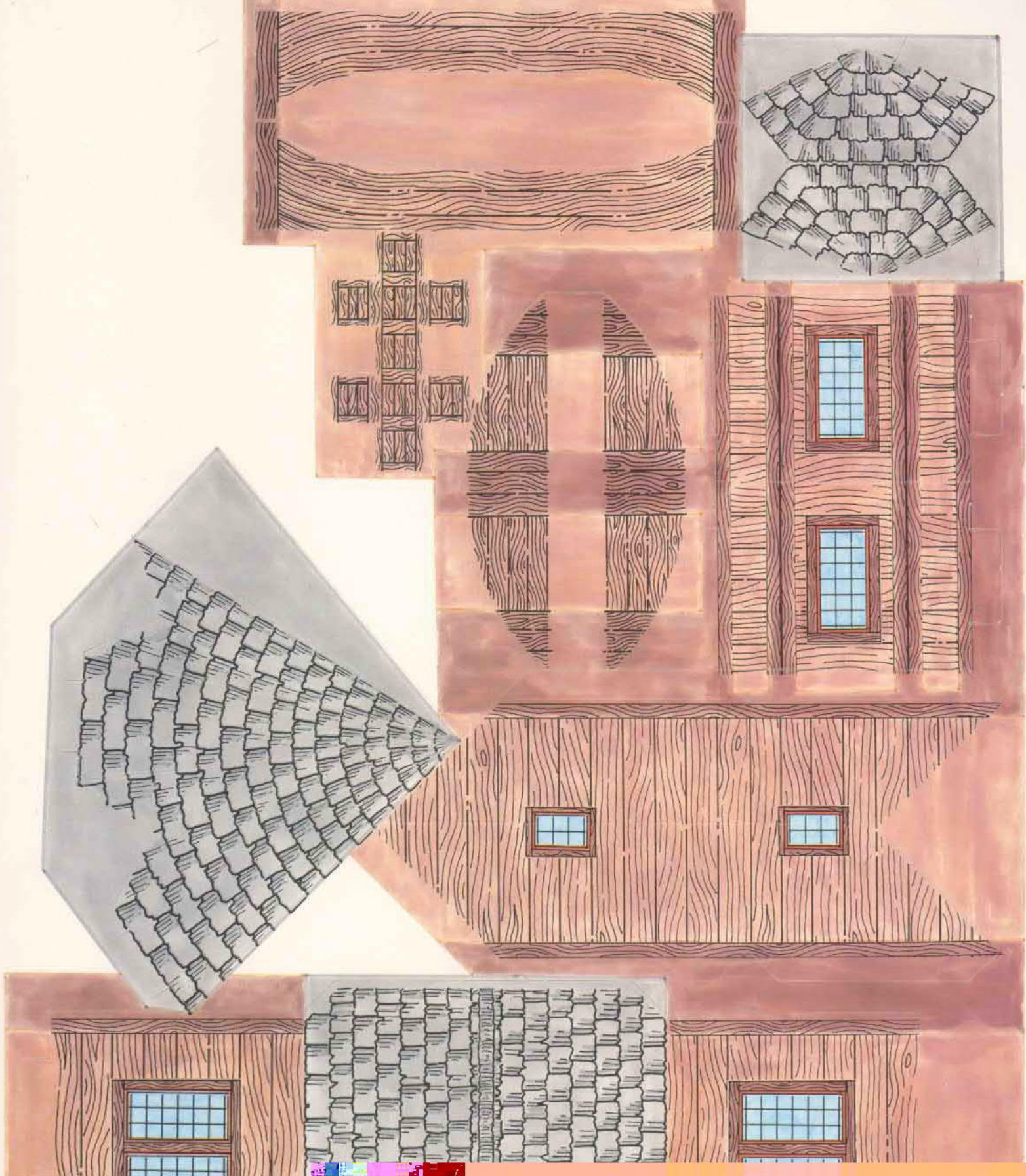



11

10b

10b

11

10b

11

10b

10c

10c

10c

10c

10c

10b

10a

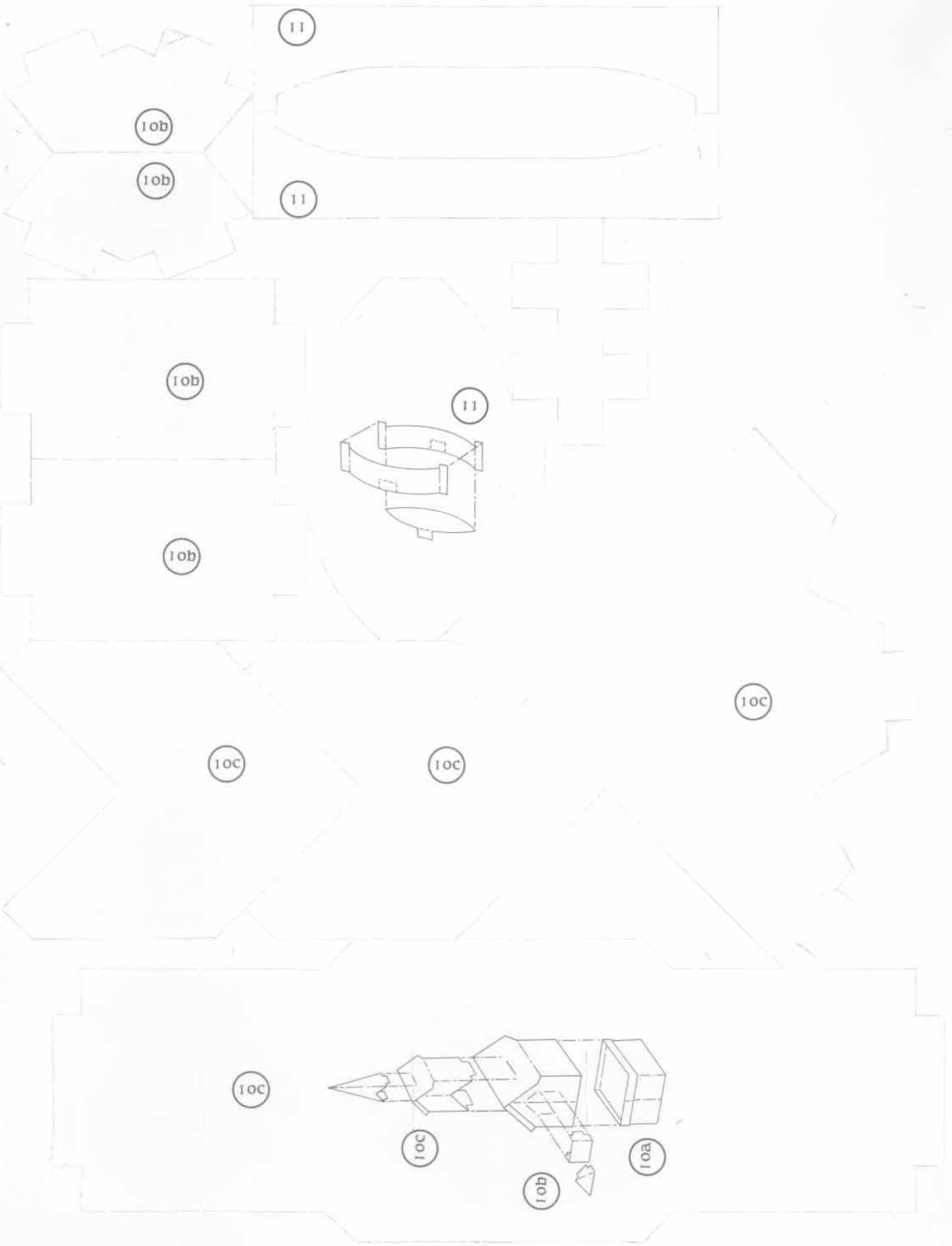

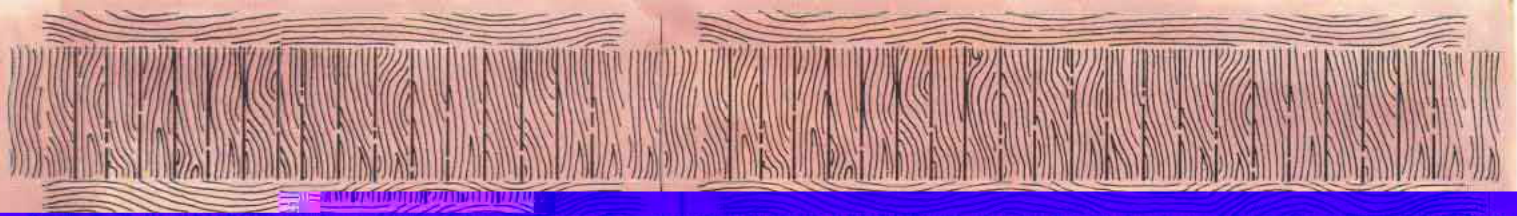



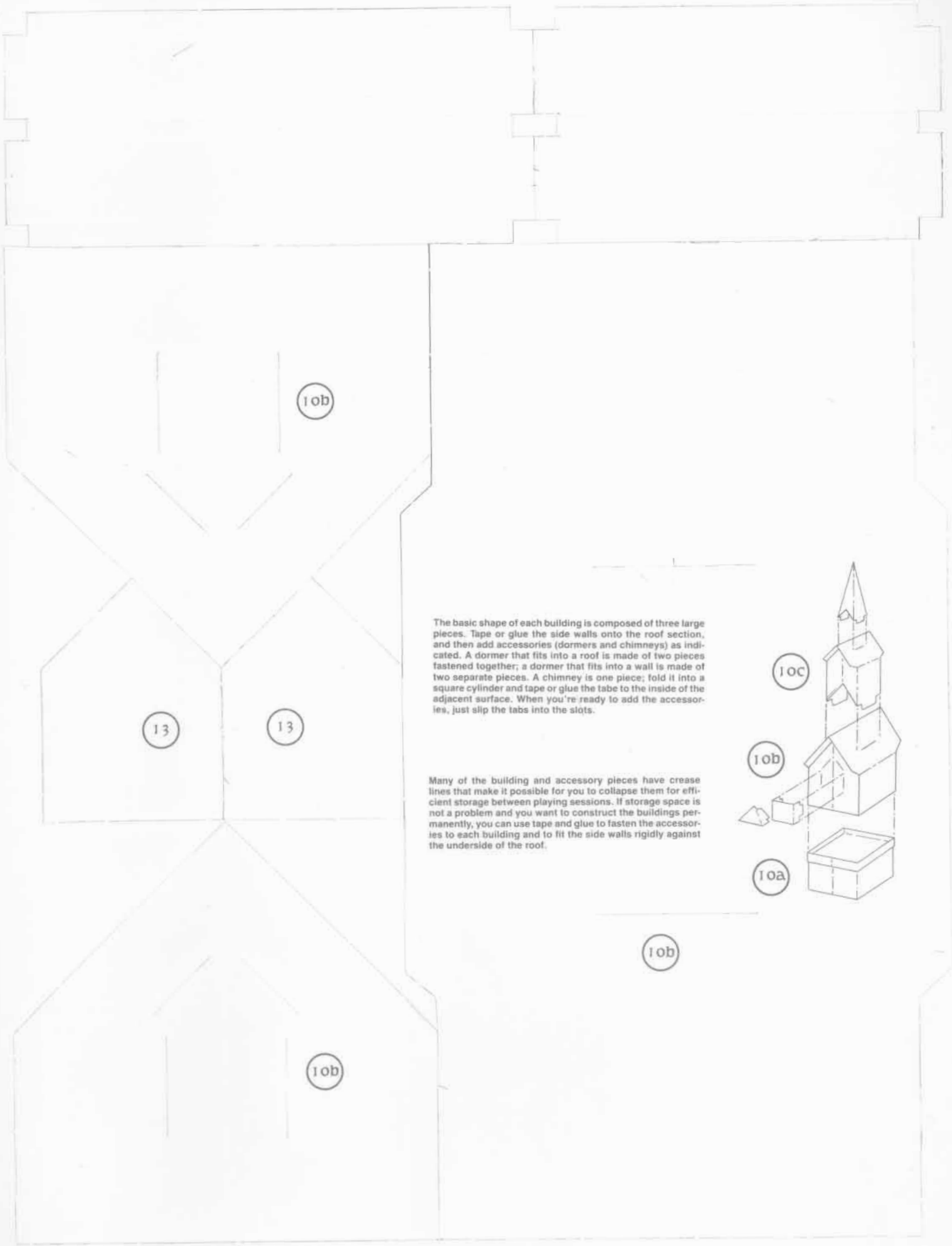

10b

13

13

10b

10b

The basic shape of each building is composed of three large pieces. Tape or glue the side walls onto the roof section, and then add accessories (dormers and chimneys) as indicated. A dormer that fits into a roof is made of two pieces fastened together; a dormer that fits into a wall is made of two separate pieces. A chimney is one piece; fold it into a square cylinder and tape or glue the tabs to the inside of the adjacent surface. When you're ready to add the accessories, just slip the tabs into the slots.

Many of the building and accessory pieces have crease lines that make it possible for you to collapse them for efficient storage between playing sessions. If storage space is not a problem and you want to construct the buildings permanently, you can use tape and glue to fasten the accessories to each building and to fit the side walls rigidly against the underside of the roof.

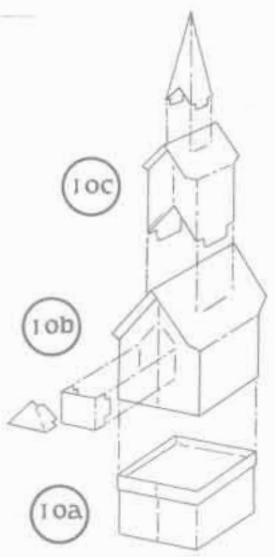

10c

10b

10a





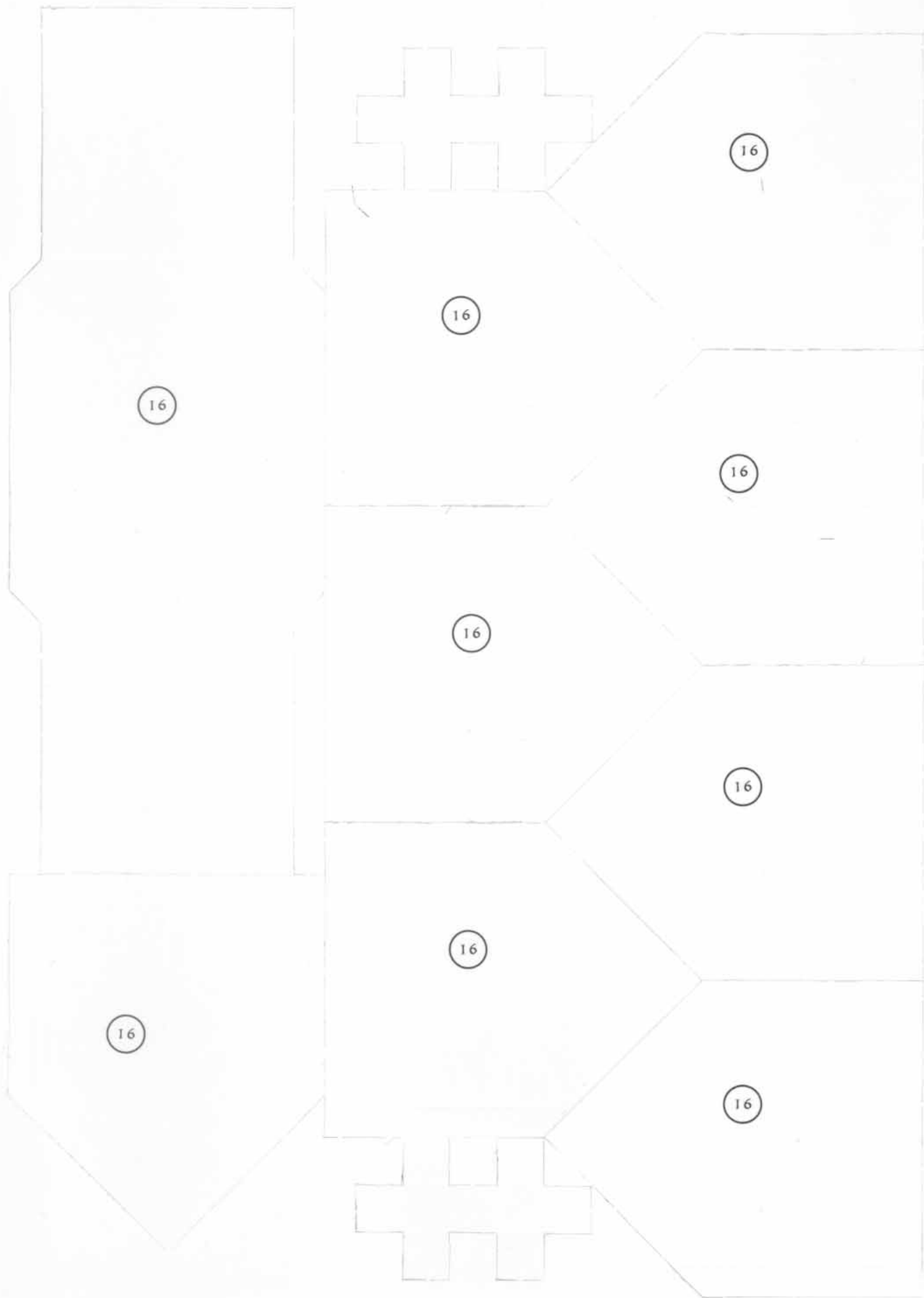



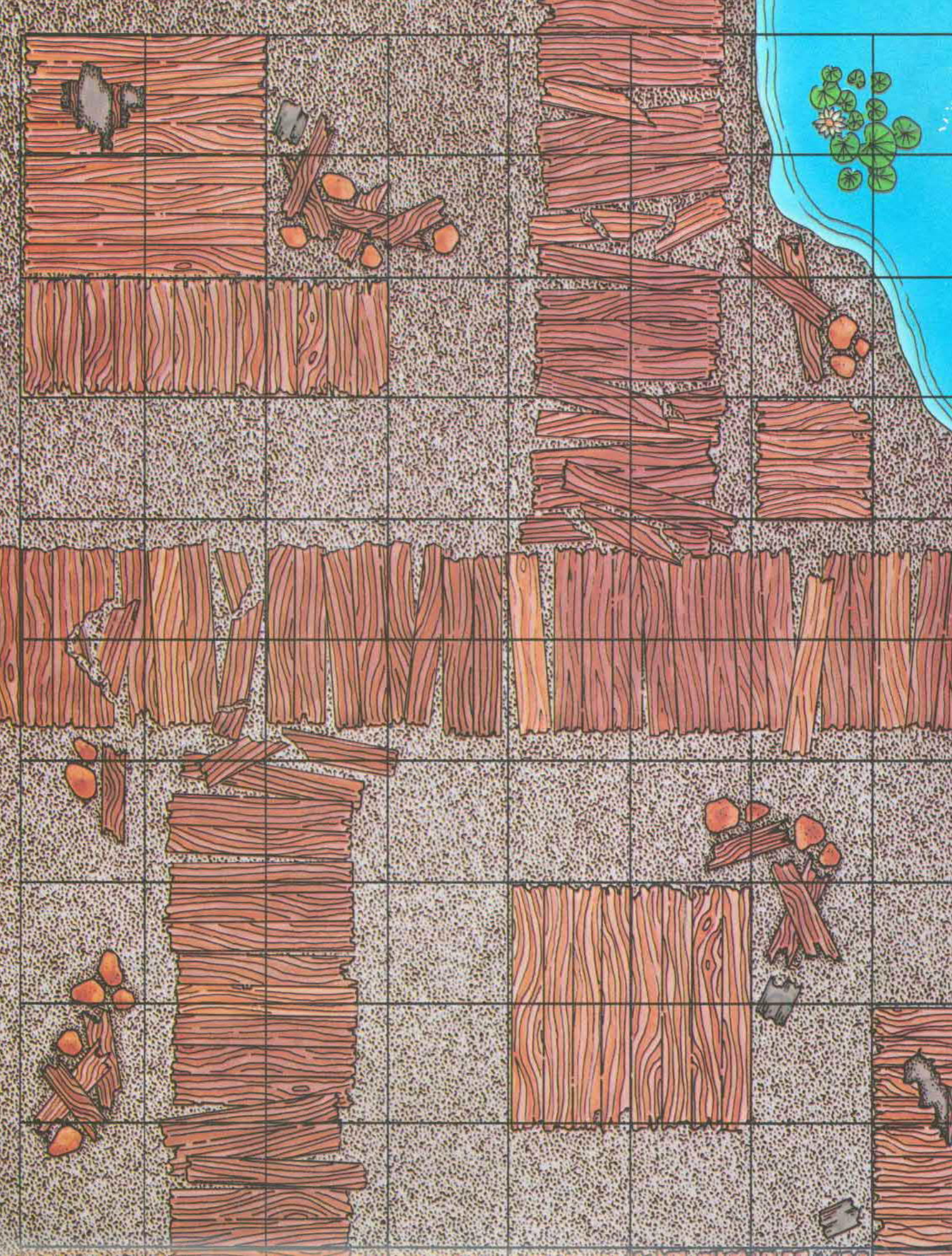



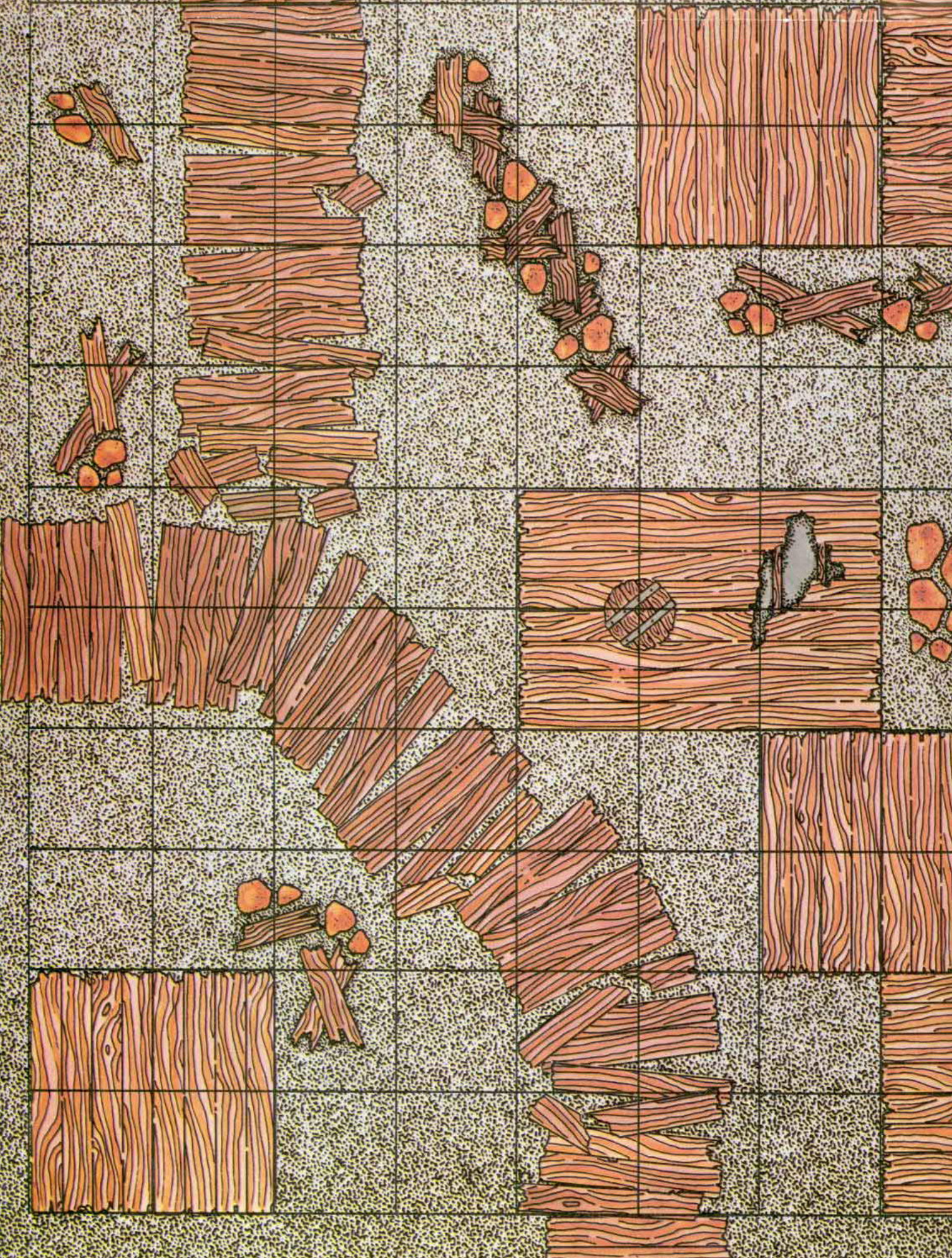











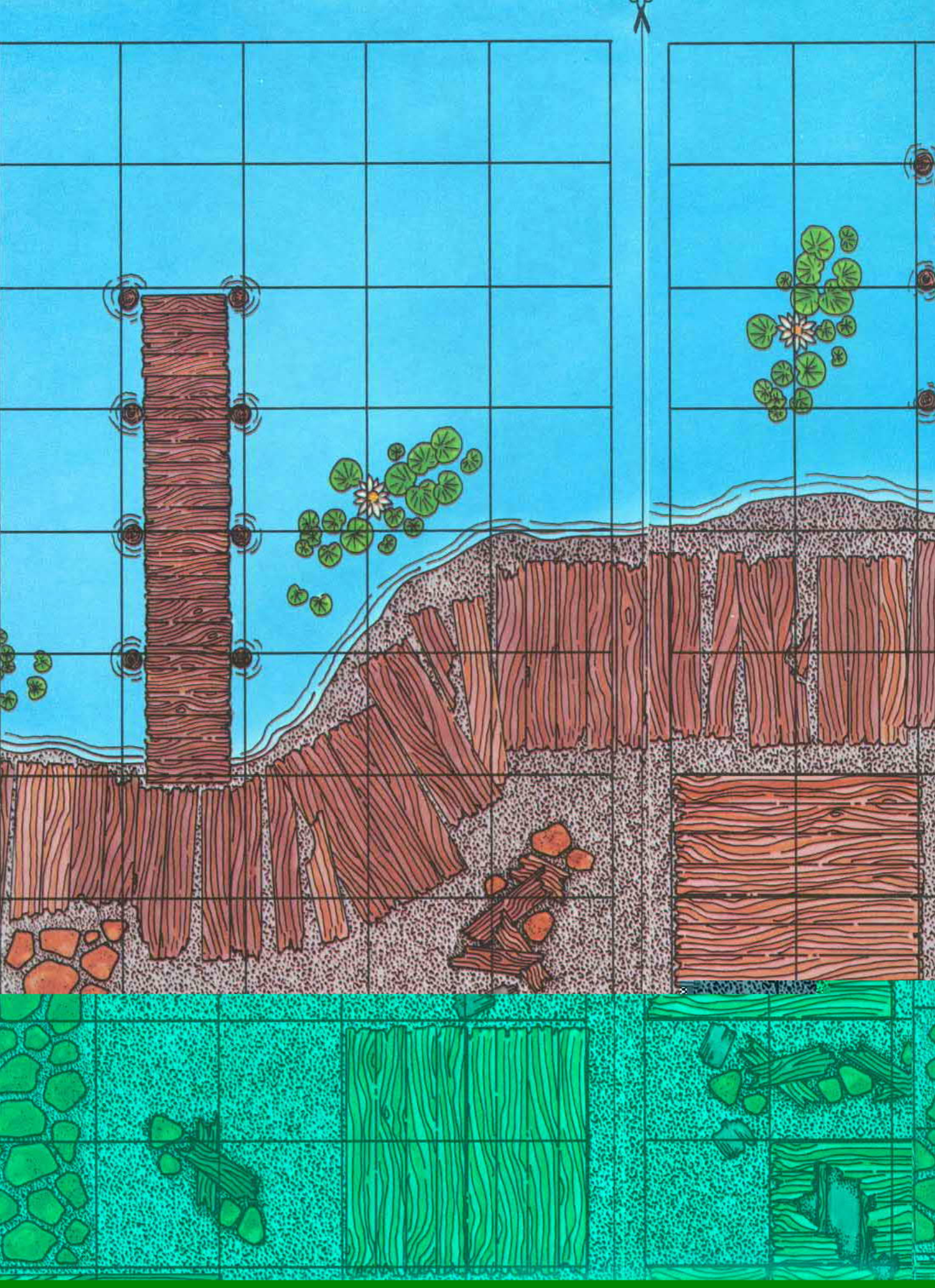











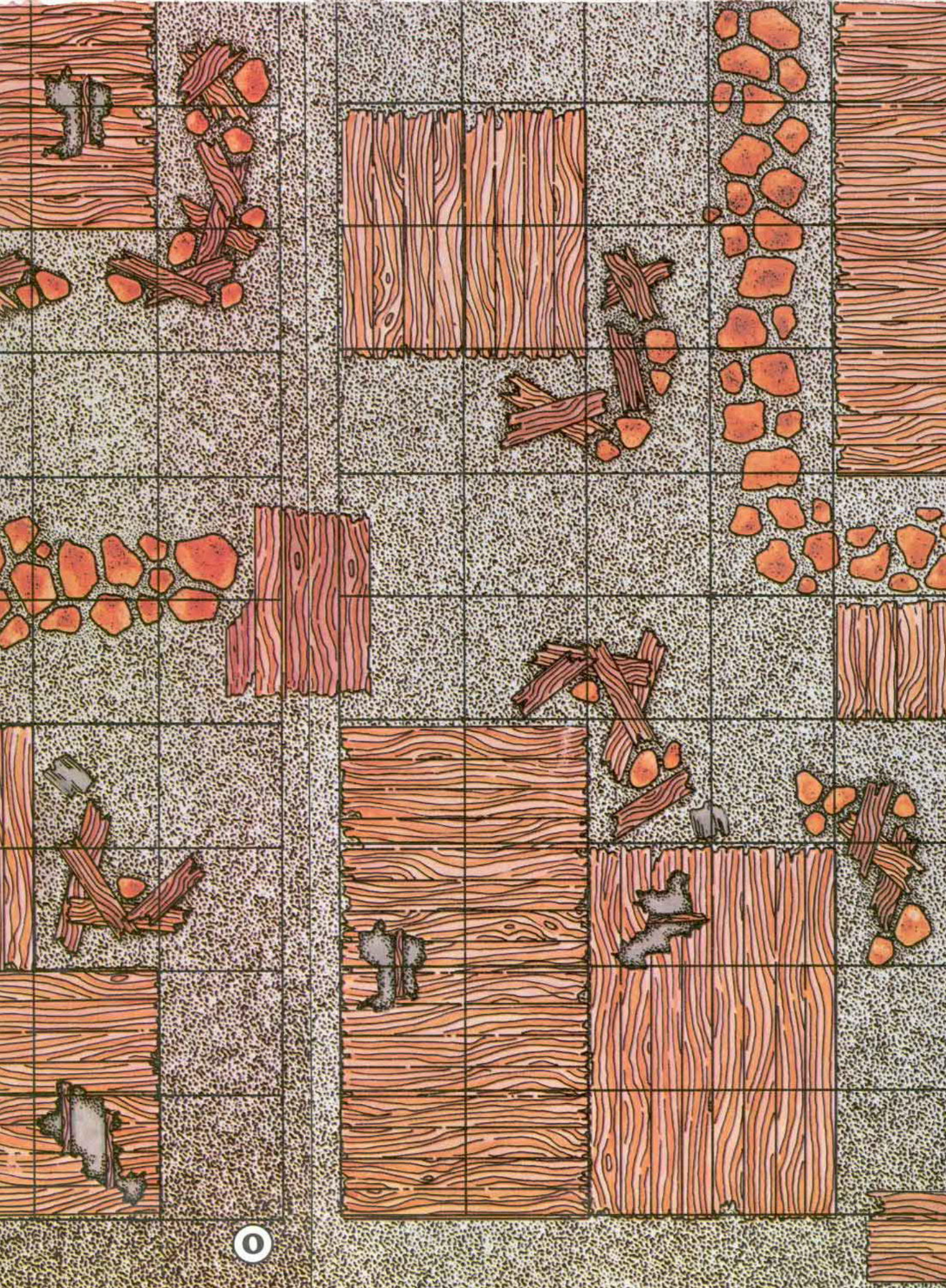



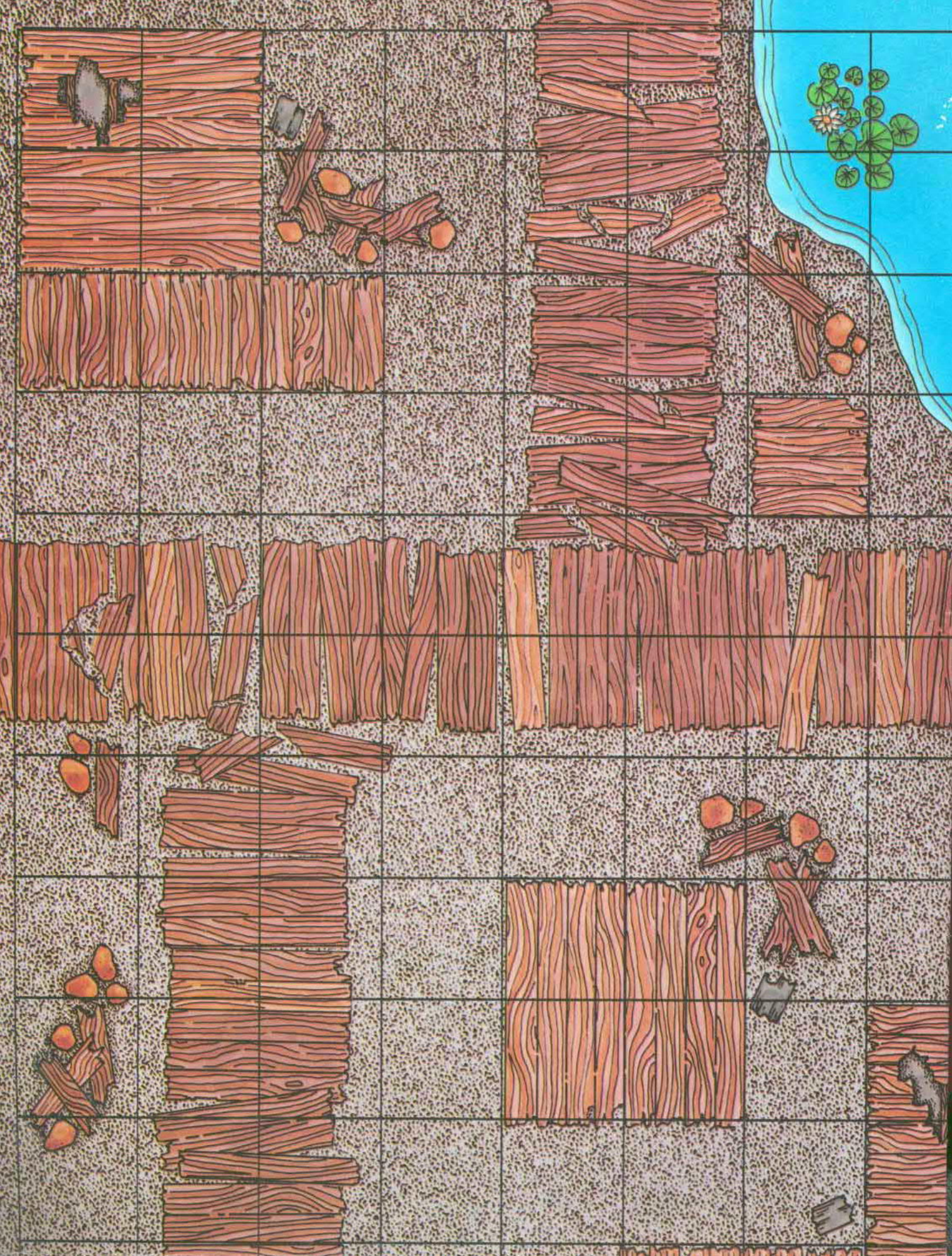



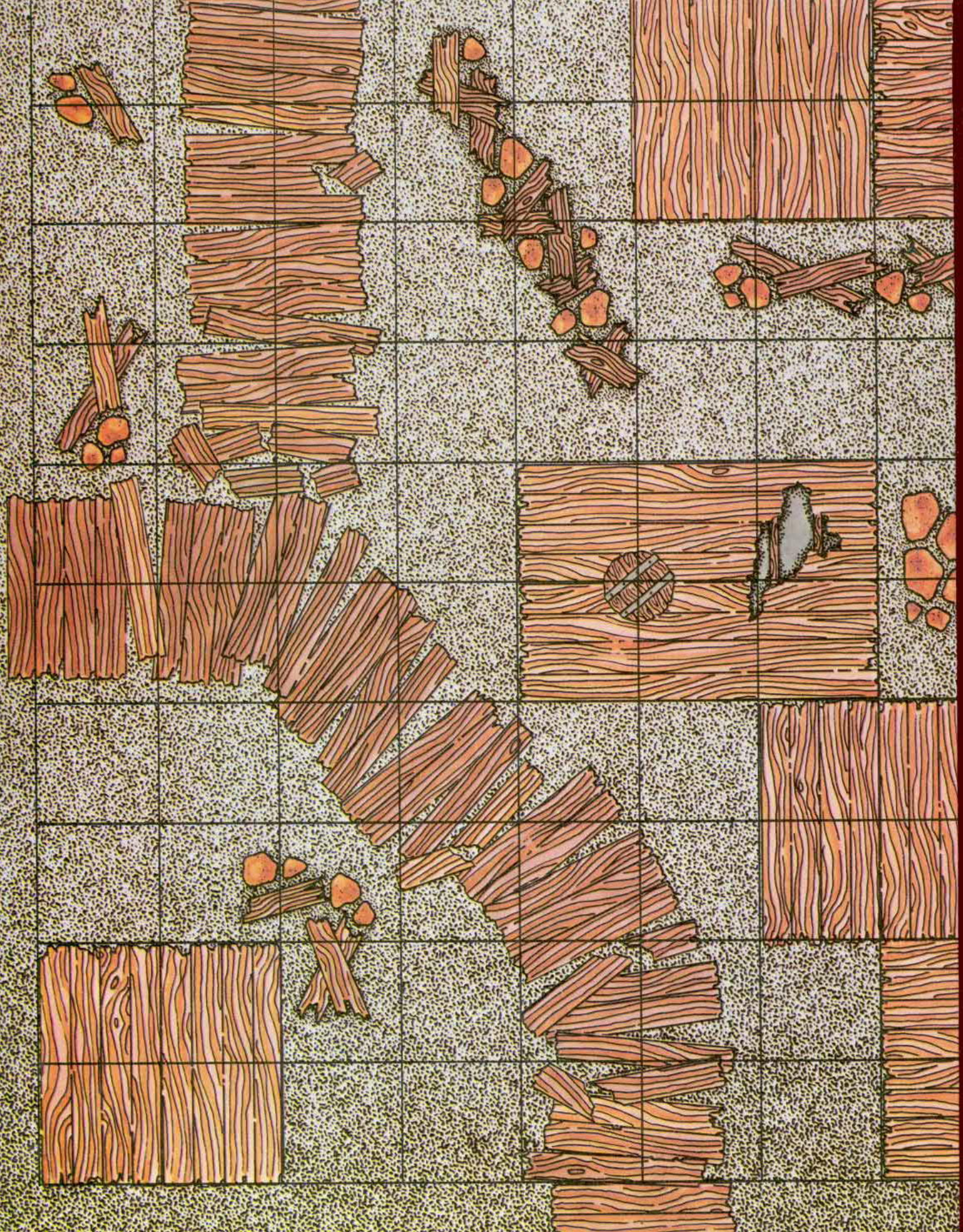



Advanced Dungeons & Dragons  
2nd Edition

# GREYHAWK® ADVENTURES

Official Game Adventure

## Falcon's Revenge

by Richard W. and Anne Brown

The Free City of Greyhawk beckons. Touted as the Gem of the Flanaess, it offers excitement and adventure in the form of magic to be learned, deals to be made, and streets to be explored. But wait—something else lurks here that threatens adventurers at every turn. Is someone following you—or is it your imagination? Why is your party receiving threats—you've been in town only a few days!

Something evil *does* lurk in Greyhawk. But before it can be eliminated, it must

first be discovered. Can your party find it before it finds you?

*Falcon's Revenge* is the first of a three-part series of adventures for the ADVANCED DUNGEONS & DRAGONS® 2nd Edition role-playing game, but it can also stand alone. Set in the famed City of Greyhawk, it gives adventurers a taste of life in the big city—with *someone* or *something* brewing trouble.

*Falcon's Revenge* is designed for five to seven characters of levels 5 to 7.



Shown at left are just a few of the full-color fold-up buildings included with this adventure. Representing a portion of the structures in the City of Greyhawk, they work with the *Cities*



TSR, Inc.

*of Mystery* building set (right) to create an exciting and complete gaming environment! Lead miniatures not included.



TSR, Inc.  
POB 756  
Lake Geneva,  
WI 53147  
U.S.A.

ISBN 0-88038-830-7



TSR Ltd.  
120 Church End  
Cherry Hinton  
Cambridge CB1 3LB  
United Kingdom

9279XXX1401

\$8.95 U.S.